

DAY COLLECTION

Rimadesio

7 BOOKCASES

10 ZENIT, 50 OPUS, 68 WIND

89 STORAGE UNIT SYSTEMS

92 RIALTO, 120 ALAMBRA, 176 ABACUS LIVING

IT Dalle librerie agli espositori vetrina, dai sistemi componibili alle madie: la collezione Day raccoglie tutte le proposte Rimadesio dedicate al contenimento per la zona giorno. Soluzioni definite per specifiche funzioni, caratterizzate da un'estrema attenzione ad ogni dettaglio, da un design rigoroso e dalle infinite possibilità di personalizzazione grazie ad un'ampia scelta di materiali e finiture esclusive.

DE Vom Bücherregal bis zur Vitrine, vom Modulsystem bis zum Sideboard: Die Kollektion Day vereint alle Lösungen von Rimadesio für das Aufbewahren im Wohnbereich. Lösungen, die für spezifische Funktionen definiert wurden und sich durch eine extreme Aufmerksamkeit für jedes Detail, ein anspruchsvolles Design und dank einer großen Auswahl an exklusiven Materialien und Verarbeitungen durch endlose Möglichkeiten auszeichnen.

FR Des bibliothèques aux vitrines, des systèmes modulaires aux bahuts: la collection Day regroupe tous les produits Rimadesio dédiés au rangement pour la zone jour. Des solutions définies pour des fonctions spécifiques, caractérisées par une extrême attention à chaque détail, par un design rigoureux et par les possibilités infinies de personnalisation, grâce à un large choix de matériaux et de finitions exclusives.

ES De las librerías a las vitrinas, de los sistemas modulares a los aparadores: la colección Day systems incluye todos los productos Rimadesio dedicados a la contención para la zona día. Soluciones definidas para funciones específicas, caracterizadas por una extrema atención a cada detalle, por un diseño riguroso y por las infinitas posibilidades de personalización gracias a una amplia selección de materiales y acabados exclusivos.

RU В коллекции Day представлены все предложения Rimadesio, предназначенные для хранения вещей в жилой зоне: от книжных шкафов до шкафов-витрин, от модульных систем до тумб. Решения, предназначенные для выполнения конкретных функций, характеризуются исключительным вниманием к каждому элементу, строгим дизайном и бесконечными возможностями оптимизации под нужды заказчика благодаря широкому выбору эксклюзивных материалов и отделки.

汉语 从书柜到玻璃展示柜、从模块化系统到餐边柜：Day 日间系列涵盖 Rimadesio 所有日间空间的收纳方案。这些解决方案皆针对特定功能研发，有赖于广泛的材质选择与独家的表面处理，设计严谨、高度注重每个细节，无限客制化可能性为其特色。

FROM BOOKCASES TO DISPLAY CABINETS, FROM MODULAR SYSTEMS TO SIDEBOARDS; THE DAY COLLECTION INCLUDES ALL RIMADESIO PRODUCTS DEDICATED TO STORAGE FOR THE LIVING AREA. SOLUTIONS DEFINED FOR SPECIFIC FUNCTIONS, CHARACTERIZED BY AN EXTREME ATTENTION TO EVERY DETAIL, BY A RIGOROUS DESIGN AND BY THE INFINITE POSSIBILITIES OF CUSTOMIZATION THANKS TO A WIDE CHOICE OF MATERIALS AND EXCLUSIVE FINISHINGS.

BOOKCASES

10 ZENIT, 50 OPUS, 68 WIND

BOOKCASES



THE ICONIC BOOKCASE IN THE PURSUIT OF LIGHTNESS AND PROJECT VERSATILITY. THE UPRIGHTS, FIXED FROM FLOOR TO CEILING AND ALWAYS CUSTOM-MADE, ALLOW A FREE POSITIONING OF THE ELEMENTS, IN THE DESIRED NUMBER AND AT THE DESIRED HEIGHT. THE EXCLUSIVE HOOKING SYSTEM ELEMENT GUARANTEES THE MAXIMUM STRUCTURAL SOLIDITY AND ALLOWS TO LEVEL EVERY ELEMENT.

IT La libreria all'insegna della leggerezza e della versatilità compositiva. I montanti, fissati da terra a soffitto e sempre su misura, permettono una libera disposizione delle attrezzature, nel numero e all'altezza desiderata. Un progetto versatile, pensato per esporre e contenere, destinato alla casa e agli spazi professionali. La varietà delle finiture, dal vetro alle essenze fino alle superfici in alluminio, consente una perfetta integrazione stilistica in ogni ambiente.

DE Das Bücherregal zeichnet sich durch Leichtigkeit und Vielseitigkeit aus. Die in Sondermaßen Pfosten, vom Boden bis zum Decke fixiert, ermöglichen dem Kunden eine freie Anordnung der Ausrüstung, in der gewünschten Anzahl und Höhe. Dies ist ein vielseitiges, für den häuslichen und professionellen Raum bestimmtes Modell, das entworfen wurde, um hergezeigt zu werden und um etwas zu verstauen. Die Vielfalt an Oberflächenmaterialien, von Glas über Holz bis zu den Aluminium-oberflächen, ermöglicht eine perfekte stilistische Integration in jeder Umgebung.

FR La bibliothèque caractérisée par la légèreté et la polyvalence de la composition. Les montants, fixés du sol au plafond et toujours sur mesure, permettent une disposition libre de l'équipement, dans le nombre et à la hauteur désirées. Un projet polyvalent, conçu pour exposer et contenir, destiné à la maison et aux espaces professionnels. La variété des finitions, du verre au bois, aux surfaces en aluminium, permet une intégration stylistique parfaite dans chaque environnement.

ES La librería se caracteriza por su ligereza y versatilidad compositiva. Los montantes, fijados al suelo y techo y siempre a medida, permiten una disposición libre del equipamiento, en el número y altura deseados. Un proyecto versátil, diseñado para exhibir y contener, destinado para el hogar y espacios profesionales. La variedad de acabados, del vidrio a las esencias y superficies de aluminio, permite una perfecta integración estilística en cualquier entorno.

RU Библиотека, характеризующаяся легкостью и композиционной универсальностью. Стойки, закрепленные в пол и потолок в полном соответствии с размерами заказчика, позволяют свободно размещать оснащение в нужном количестве и на нужной высоте. Универсальный дизайн, предназначенный для экспонирования и хранения, идеально впишется в домашний и профессиональный интерьер. Благодаря разнообразию вариантов отделки – от стекла до дерева и алюминиевых поверхностей – они могут идеально гармонировать с любым интерьером.

汉语 Zenit 书柜以轻巧和多样组合性著称。立柱皆按尺寸定制，固定于地板和天花板两端，可根据所需的配件数量和高度自由配置。多样的玻璃与木材表面处理以及铝合金打造的面为任何空间皆能营造出完美风格感。



Structure: 13 nero
Glass shelves: 63 grigio trasparente
Fronts: 700 tinto ebano taiga
Marble top: 183 noir saint laurent
W 5090 H 2655 D 500

In this photo
Table: Long Island
Wall panelling system: Modulor

EN In the bookcase version, Zenit expands its design potential with the introduction of a brand new backlit upright and new suspended cabinets which, like all Zenit accessories, can be freely positioned. The aluminium drawers with fully extractable runners are equipped with a new push opening system and soft-closing mechanism. Drawers and hinged doors fronts are available in glossy, matt, sahara, taiga and diamante lacquered glass or in Litech, in sahara and taiga wood with a three-dimensional effect, with a total of 165 finishings.

IT Nella versione libreria Zenit amplia le proprie potenzialità progettuali con l'introduzione di un montante retroilluminato e di contenitori sospesi che, come tutte le attrezzature di Zenit, sono liberamente posizionabili. I cassetti in alluminio, con guide ad estrazione totale sono dotati di un inedito sistema di apertura push e rientro ammortizzato. Il rivestimento dei cassetti e delle ante è disponibile in vetro laccato lucido, opaco, sahara, taiga e diamante oppure in Litech, in essenza sahara e taiga con effetto tridimensionale, per un totale di 165 finiture.

DE In der Ausführung als Bücherregal erweitert Zenit sein Gestaltungspotenzial durch die Einführung einer hinterleuchteten Basis und von Hängeschränken, die, wie alle Zenit-Einrichtungen, frei positioniert werden können. Die Aluminium-Schubladen mit Vollauszug sind mit einem neuartigen Push-Open-System und Soft-Close-Rückführung ausgestattet. Die Paneele der Schubladen und Türen sind in glänzend oder matt lackiertem Glas, Taiga, Sahara und Diamante oder in Litech, Sahara- und Taigaholz mit dreidimensionalem Effekt erhältlich, insgesamt stehen 165 Ausführungen zur Verfügung.

FR Dans sa version bibliothèque, Zenit élargit son potentiel modulaire avec l'introduction d'un montant rétroéclairé et d'éléments de rangement suspendus qui, comme tous les équipements Zenit, peuvent être librement positionnés. Les tiroirs en aluminium, qui disposent de glissières entièrement extractibles, sont équipés d'un système inédit d'ouverture à pression avec amortisseur de fermeture. Le revêtement des tiroirs et des portes est disponible en verre laqué brillant, mat, sahara, taiga et diamante ou en Litech, dans les essences sahara et taiga avec effet 3D, pour un total de 165 finitions disponibles.

ES En su versión de librería, Zenit amplía su potencial de diseño espacial con la introducción de un inédito elemento vertical retroiluminado y contenedores suspendidos que, como todos los productos de Zenit, se pueden colocar libremente. Los cajones de aluminio, con guías totalmente extraíbles, cuentan con un inédito sistema de apertura push y retorno amortiguado. El revestimiento de cajones y puertas está disponible en vidrio lacado brillante, opaco, sahara, taiga y diamante o en Litech, en madera sahara y taiga con efecto tridimensional, para un total de 165 acabados.

RU В стеллажа Zenit расширяет свои собственные проектные возможности благодаря использованию стойки с подсветкой и подвесным ящикам для хранения, которые, как и все навесные элементы Zenit, можно размещать в любом месте. Алюминиевые ящики с направляющими полного выдвижения оснащены новой системой пуш-пулл с амортизаторами. Отделка ящиков и фасадов доступна из глянцевого, матового, крашеного стекла, а также декоративного стекла sahara, taiga и diamante, а также из Litech, шпона sahara и taiga с трехмерным эффектом – всего доступно 165 вариантов отделки.

汉语 Zenit 书柜扩大了设计潜力，推出背部照明式立柱和悬吊式收纳空间，如同 Zenit 的所有部件，它们皆可自由配置。铝合金打造的抽屉设有抽拉式导轨，并搭配新型推弹系统和软关闭功能。抽屉和门扇的表面处理有亮面漆和哑光漆玻璃、Sahara、Taiga、Diamante、和 Litech 岩板可供选择；Sahara 木材和 Taiga 木材具有立体效果，共有 165 表面处理可供选择。

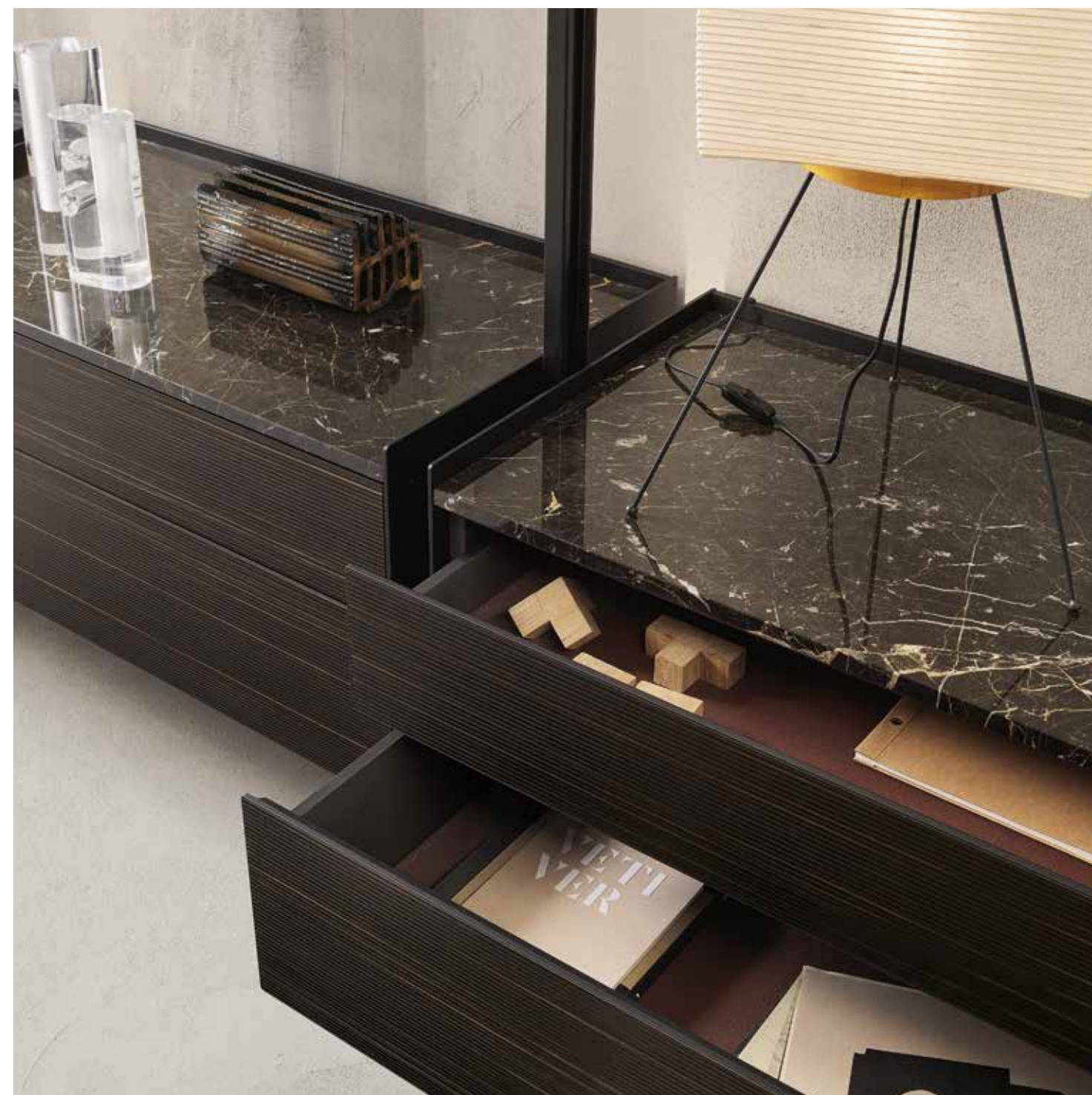

Structure: 13 nero
Glass shelves: 63 grigio trasparente
Fronts: 700 tinto ebano taiga
Marble top: 183 noir saint laurent
Internal drawers in synthetic leather: 156 rubens



EN The indirect lighting system allows a latest generation LED to be inserted into the iconic upright which is only 25 mm wide, keeping the design of the original 1997 ceiling and wall fixing system unchanged. Thus, the Zenit bookcase system can be updated and improved over time without replacements or aesthetic variations, in line with the sustainability and durability common to the Rimadesio collection.

IT Il sistema di illuminazione a luce indiretta permette di inserire un led di ultima generazione nell'iconico montante di soli 25 mm di larghezza, mantenendo immutato il design del sistema di fissaggio a soffitto e a parete originale del 1997. In questo modo, il sistema libreria Zenit viene aggiornato e migliorato nel tempo senza sostituzioni né variazioni estetiche, in un'ottica di sostenibilità e durabilità comune agli arredi Rimadesio.

DE Das indirekte Beleuchtungssystem ermöglicht es, eine hochmoderne LED in der ikonischen Decken- und Wandmontagesystems von 1997 beizubehalten. Auf diese Weise wird das Bücherregalsystem Zenit im Laufe der Zeit aktualisiert und verbessert, ohne dass es ersetzt oder ästhetisch verändert werden muss, unter dem Aspekt der Nachhaltigkeit und Langlebigkeit, die für die Möbel von Rimadesio selbstverständlich sind.

FR Le système d'éclairage indirect permet d'insérer une LED de dernière génération dans le montant emblématique de seulement 25 mm de large, en conservant intact le design du système de fixation au plafond et au mur, dont l'origine remonte à 1997. Le système de bibliothèque Zenit est ainsi actualisé et amélioré au fil du temps sans remplacements ni modifications esthétiques, dans cette optique éco-responsable et durable propre aux meubles Rimadesio.

ES El sistema de iluminación indirecta permite insertar un LED de última generación en el icónico montante de solo 25 mm de ancho, manteniendo intacto el diseño del sistema original de fijación a techo y a pared de 1997. De esta forma, el sistema de librería Zenit se actualiza y mejora en el tiempo sin sustituciones ni variaciones estéticas, con la mirada puesta en la sostenibilidad y la durabilidad propias del mobiliario Rimadesio.

RU Система непрямого освещения позволяет встроить современный светодиод в культовую стойку шириной всего 25 мм, сохранив при этом дизайн оригинальной системы крепления к потолку и стене 1997 года. Таким образом, без значительных эстетических изменений система книжных шкафов Zenit была обновлена и улучшена в соответствии с современными тенденциями с целью обеспечения устойчивости и долговечности, характерных для мебели Rimadesio.

汉语 间接照明系统能将最新一代的 LED 灯嵌入宽度仅 25 毫米的经典款立柱内，保留了 1997 年天花板和墙面固定系统的设计。通过此法，Zenit 改良书柜系统与与时俱进，不断更新改良，美感却始终如一，进而体现 Rimadesio 家具可持续发展性和耐用性的共同点。

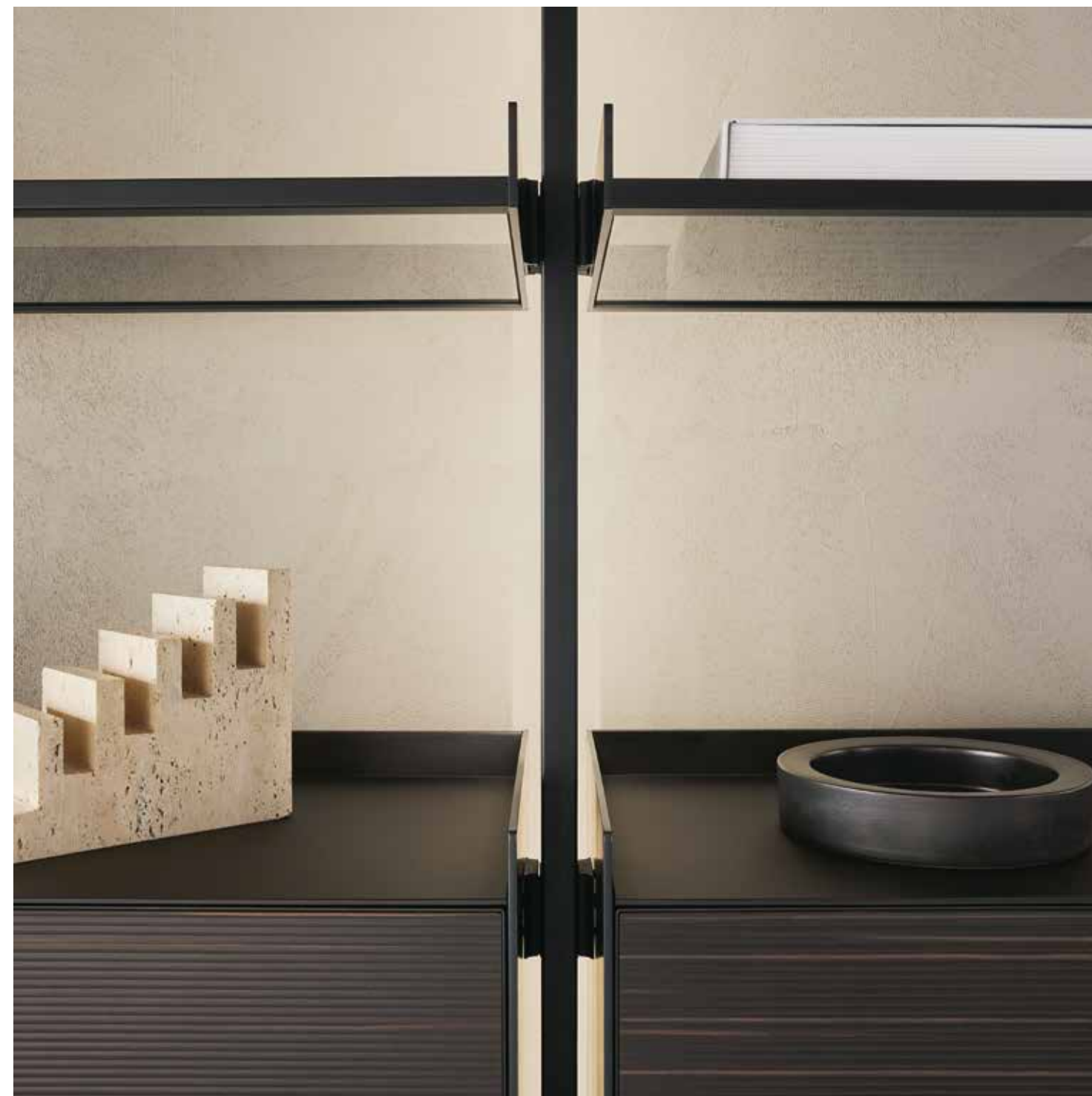

Structure: 13 nero
Glass shelves: 63 grigio trasparente
Fronts: 700 tinto ebano taiga





EN The aluminium upright guarantees the maximum structural solidity. The bayonet fixing system allows every single element to be installed perfectly leveled. The wall and ceiling uprights allow any possible composition.

IT Il montante in alluminio garantisce la massima solidità strutturale alle composizioni Zenit e il sistema di aggancio a baionetta consente di posizionare in bolla ogni singolo elemento. I montanti sono disponibili "a soffitto" e "a parete" per consentire la collocazione del sistema in ogni ambiente.

DE Der Montageposten aus Aluminium garantiert eine maximale Stabilität für eine Zenit Kompositionen und das Bajonettkupplungssystem ermöglicht ein waagerechte Positionierung jedes einzelnen Elements. Diese Montageposten sind als Decken- und Wand-Montage erhältlich, sodass das System in jeder Raum platziert werden kann.

FR Le montant en aluminium garantit une solidité structurelle maximale aux compositions Zenit et le système de fixation à baïonnette permet de positionner à niveau chaque élément individuel. Les montants sont disponibles à plafond et à mur pour permettre au système d'être positionné dans n'importe quel environnement.

ES El montante de aluminio garantiza la máxima solidez estructural a las composiciones Zenit y el sistema de fijación permite colocar cada elemento individual a nivel. Los montantes están disponibles "a techo" y "a pared" para permitir de colocar el sistema en cualquier situación.

RU Алюминиевая стойка гарантирует максимальную конструктивную прочность композициям Zenit, а бесшаговая система крепления позволяет выставить по уровню каждый из навесных элементов. Стойки могут крепиться к потолку или к стене, что позволяет установить систему в любом помещении.

汉语 铝制立柱保证了结构的最大坚固性。卡口式固定系统使每个元件都能完美地安装在水平面上。墙壁和天花板立柱允许任何可能的组合。

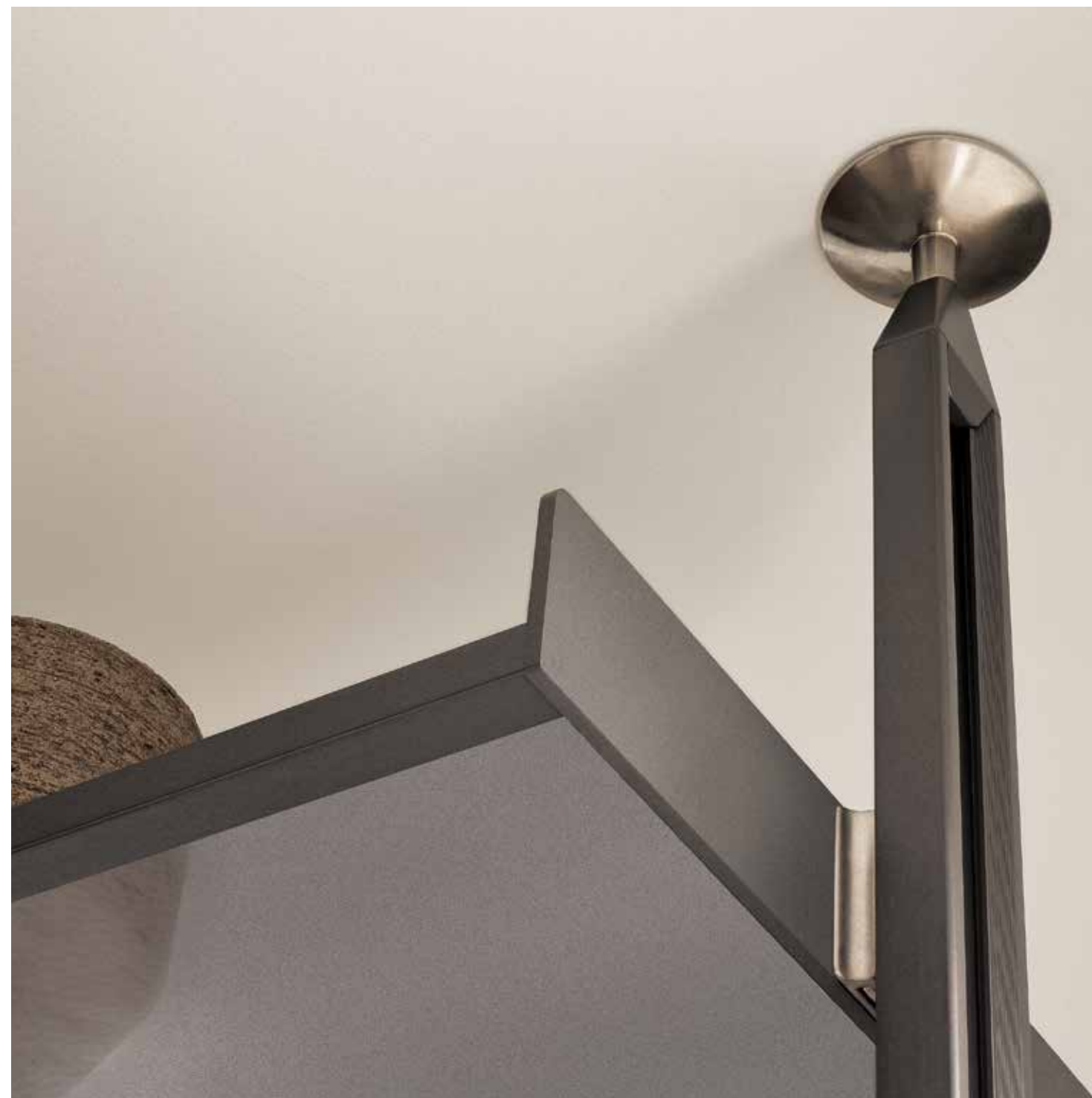







Structure: 304 platino
Fronts: 17 noce sahara
Glass shelves: 61 rete inox
Glass top: 137 platino opaco
W 6090 H 3000 D 500

In this photo
Coffee table: Tray

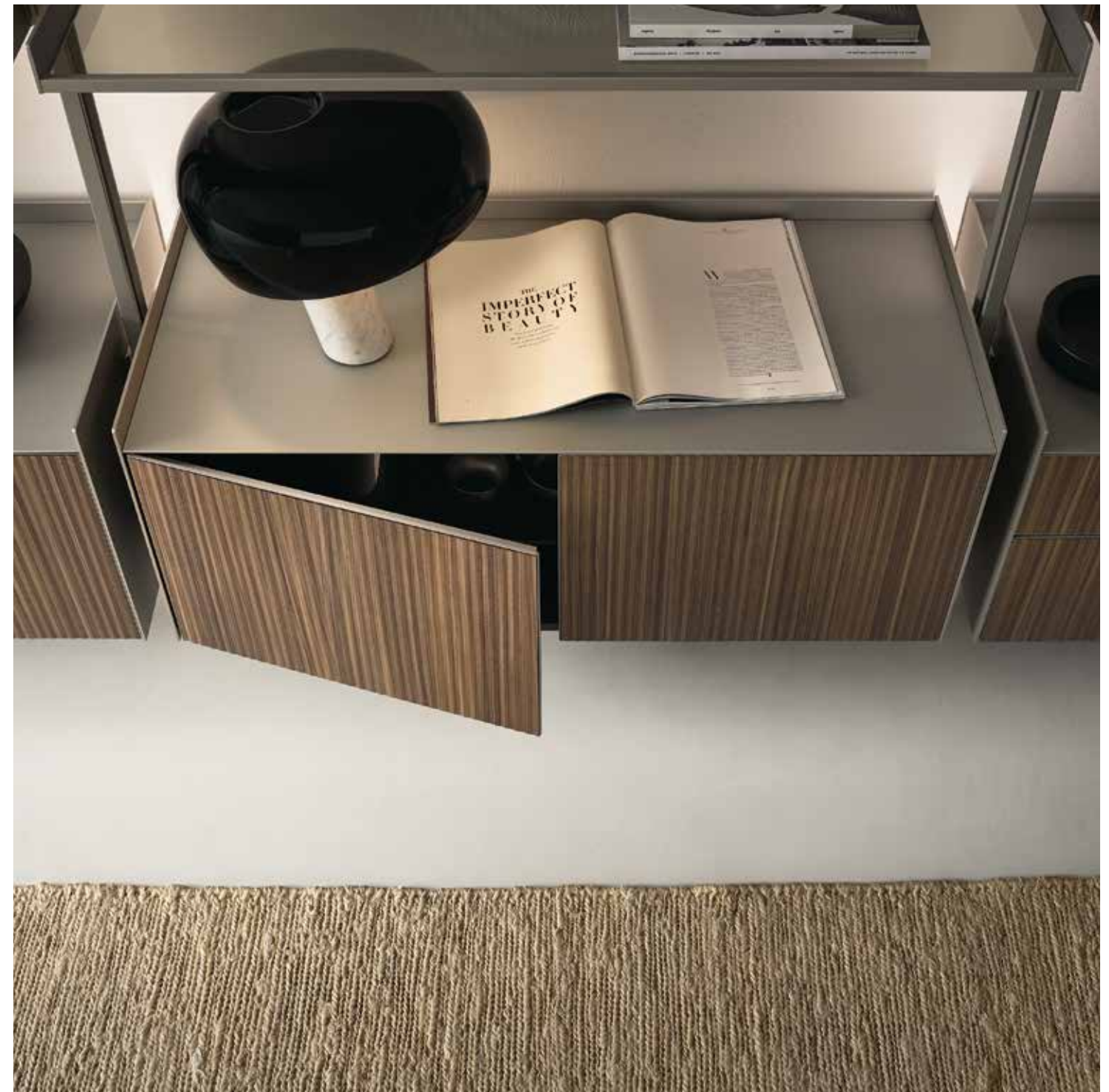

Structure: 304 platino
Fronts: 17 noce sahara
Glass shelves: 61 rete inox
Glass top: 137 platino opaco
Internal drawers in synthetic leather: 154 argilla





Structure: 304 platino
Suspended drawer unit: 404 platino diamante
Glass shelves and suspended glass cabinets:
00 trasparente
W 5090 H 2700 D 500



Structure: 304 platino
Suspended glass cabinet: 00 trasparente





Zenit bookcase

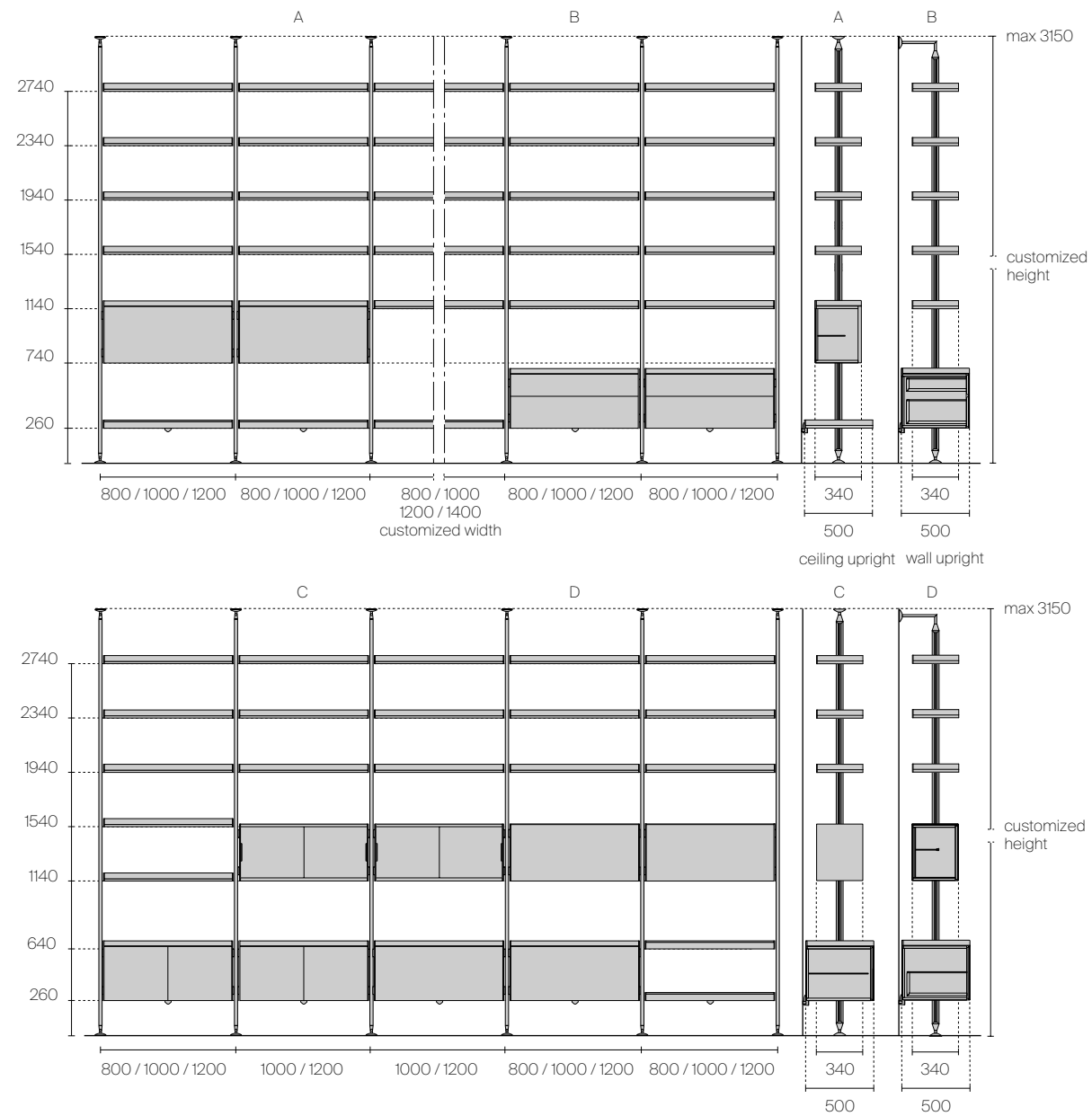

Encumbrance of the linear composition with shelves only

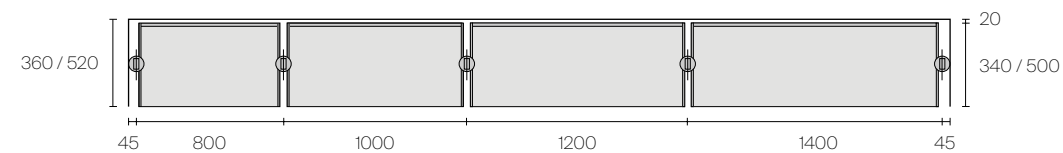

TECHNICAL DESCRIPTION

EN Zenit compositions are always custom-made in height, with wall or ceiling uprights. Shelves and TV shelf holders are available in four widths, up to a maximum size of 1400 mm.

IT Le composizioni Zenit vengono sempre realizzate su misura in altezza, con possibilità di montanti a parete o a soffitto. Le mensole e i mensoloni sono disponibili in quattro larghezze, fino alla dimensione massima di 1400 mm.

DE Zenit Anlage sind immer nach Mass in Hoehe, mit Wand oder Decke-Pfosten hergestellt. Fachboeden und Top-Fachboeden sind mit vier Breiten verfuegbar in larghezza, bis zu einer maximalen Breite von 1400 mm.

FR Les compositions Zenit sont toujours sur mesure en hauteur, avec les montants à fixation murale ou au plafond. Les étagères, et les étagères base sont disponibles en quatre largeurs, jusqu' à une dimension maxi de 1400 mm.

ES Las composiciones Zenit están siempre realizadas a medida en altura, con posibilidad de montantes a pared o a techo. Los estantes, y los estantes base están disponibles en cuatro anchuras, máxima medida de 1400 mm.

RU Композиции Zenit всегда изготавливаются по индивидуальному размеру по высоте, с возможностью настенного или потолочного монтажа стоек. Полки доступны в четырех размерах по ширине, вплоть до Максимальных 1400 мм.

汉语 Zenit 组合件的高度皆按尺寸定制，立柱可安装于墙面或天花板。层板和层板托有四种宽度可供选择，最大尺寸为 1400 毫米。

TV Hi-Fi shelf holder with lower shelf for decoder

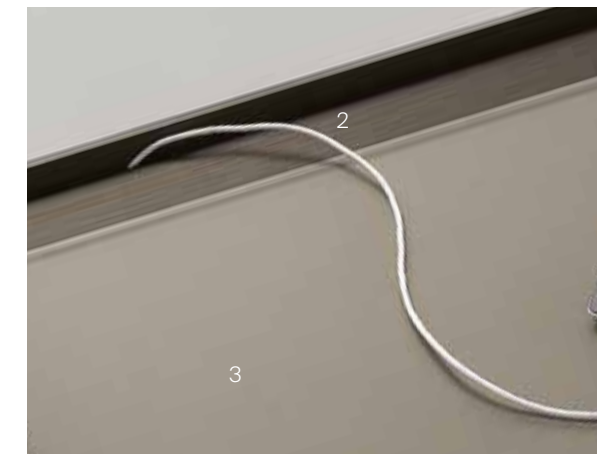

1. Aluminium support for decoder in 14 brown
2. Aluminium cable channeling in 14 brown
3. Lacquered tempered glass in 99 caffè

UPRIGHTS



1. Ceiling upright
2. Wall upright
3. Shelf with perimetrical ring in extruded aluminium
4. Bayonet fixing between the shelf and the die casting support
5. Structural upright in extruded aluminium
6. Support with expansion fixing system which allows to adjust the position of the accessories



Ceiling

Ceiling backlighted

Wall

Wall backlighted

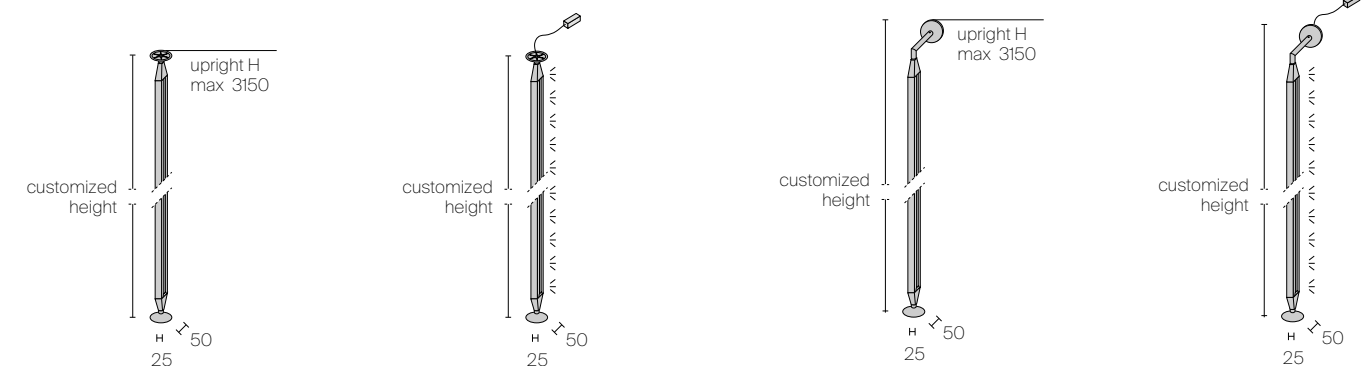

TECHNICAL DATA

Suspended unit with drawers

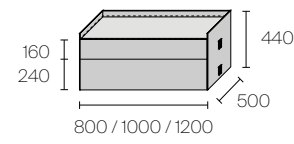

Suspended unit with drawer and flap door

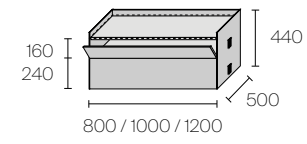

Suspended unit with drawer

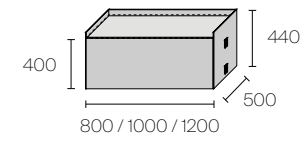

Suspended unit with hinged doors

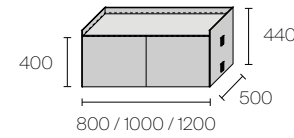

Suspended unit with flap door high side

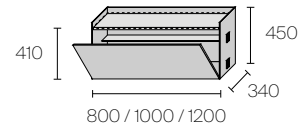

Suspended unit with flap door low side

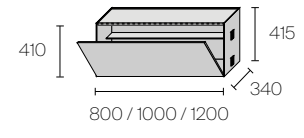

Suspended glass cabinet with sliding doors

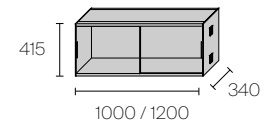

Optional glass shelf. Available for unit with hinged doors.

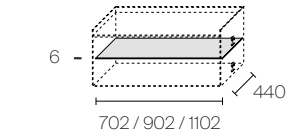

Optional synthetic leather mat for internal lining

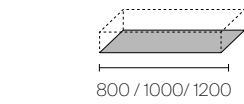

Glass finishing top thickness 4mm

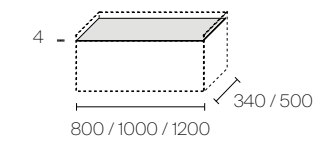

Litech finishing top thickness 4mm

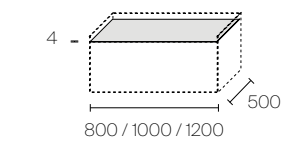

Marble finishing top thickness 20mm

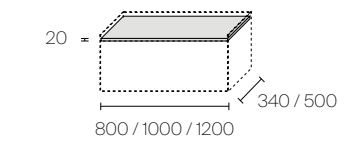

Glass shelf

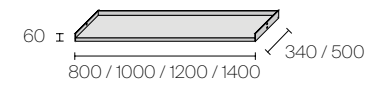

Glass shelf covered with synthetic leather

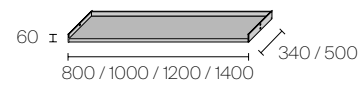

TV Hi-Fi shelf holder in lacquered glass with support for decoder

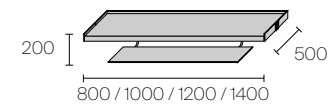

Optional adjustable wall thrust block with support for decoder

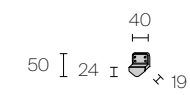

Optional cable duct for units depth 500. Not available for units with marble top.

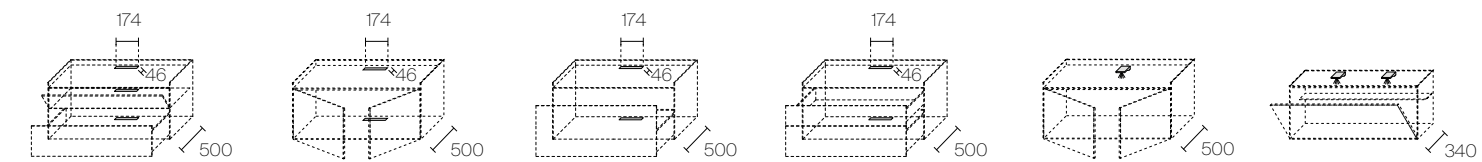

Battery led spotlight

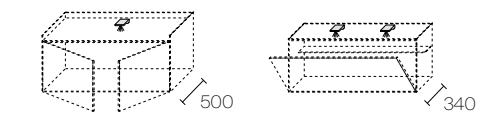

1



2



3



4



5



6



7

1. Suspended unit with drawers
2. Suspended unit with drawer and flap door
3. Suspended unit with drawer
4. Suspended unit with flap door on the low side
5. Suspended unit with hinged doors
6. Suspended unit with flap door on the high side
7. Suspended glass cabinet with sliding doors

Structure and accessories

ALUMINIUM

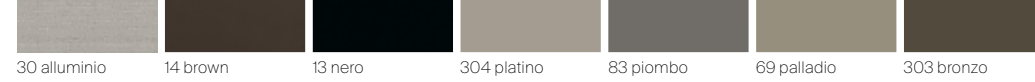

Suspended glass cabinet

TRANSPARENT GLASS

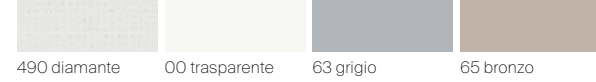

SATINATED GLASS

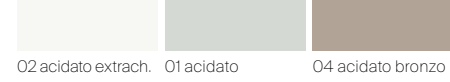

Suspended units

LACQUERED GLASS METALIZED GLASS



SAHARA GLASS



TAIGA GLASS



SAHARA METALIZED GLASS

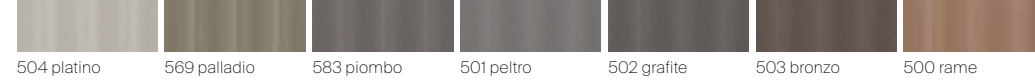

TAIGA METALIZED GLASS

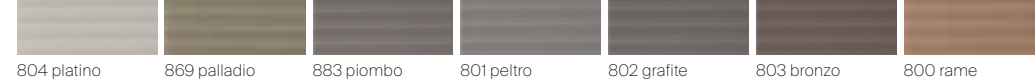

DIAMANTE GLASS



LITECH



SAHARA WOOD

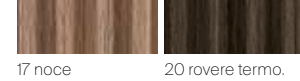

TAIGA WOOD

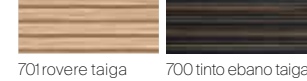

Finishing top for suspended units

LACQUERED GLASS METALIZED GLASS

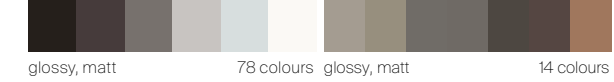

DIAMANTE GLASS



MARBLE

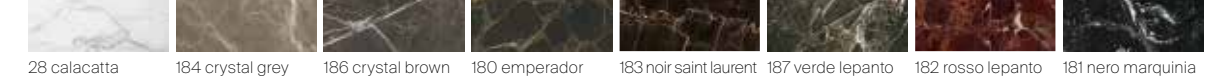

MATT MARBLE

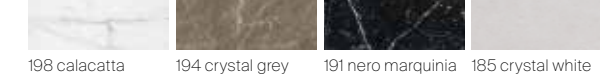

LITECH



Unit interior D 340

ALUMINIUM



Unit interior D 500

INTERNAL MELAMINE



Shelf

TRANSPARENT GLASS



SATINATED GLASS



MESH GLASS



SYNTHETIC LEATHER

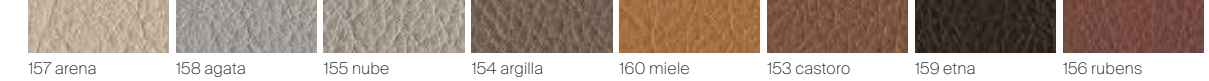

TV Hi-Fi shelf holder

LACQUERED GLASS METALIZED GLASS

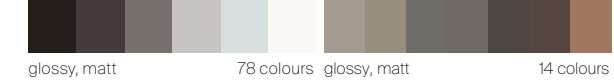

Mat for internal lining, internal flap door lining of units D 340

SYNTHETIC LEATHER





A MODULAR BOOKCASE SYSTEM, ENTIRELY IN EXTRUDED ALUMINIUM, BASED ON THE FREE COMPOSITION OF SQUARE AND RECTANGLE AS MODULAR SHAPES. A RIGOROUS GEOMETRIC IDEA WHICH ALLOWS TO CREATE BOOKCASES OF DIFFERENT DIMENSIONS WITH A STRONG SCENOGRAPHIC VALUE. PERFECTLY DOUBLE-SIDED, EQUIPPED WITH DRAWERS OR FLAP DOORS UNITS, OPUS DECORATES WITH PERSONALITY HOUSES OR PROFESSIONAL SPACES.

IT Un sistema libreria componibile, interamente in alluminio estruso, basato sulla libera composizione del quadrato e del rettangolo come figure modulari. Una concezione geometrica rigorosa che consente la definizione di librerie di varie dimensioni dal forte valore scenografico. Perfettamente bifacciale, attrezzabile con contenitori a cassetti o ante a ribalta, Opus si presta ad arredare con personalità ambienti domestici o professionali.

DE Opus ist ein modulares, komplett aus extrudiertem Aluminium hergestelltes Bücherregalsystem, das auf der freien Zusammenstellung von Quadraten und Rechtecken als modulare Figuren beruht. Es entsteht dadurch ein strenges geometrisches Konzept, das die Definition von Bibliotheken verschiedener Dimensionen mit einem starken szenographischen Wert ermöglicht. Dieses zweiseitige Regal kann mit Schubladen oder Klapptüren ausgestattet werden und eignet sich für die persönliche Einrichtung des Zuhauses oder der beruflichen Umgebung.

FR Un système de bibliothèque modulaire, entièrement en aluminium extrudé, basé sur la composition libre du carré et du rectangle comme figures modulaires. Un concept géométrique rigoureux qui permet la définition de bibliothèques de différentes dimensions avec une forte valeur scénographique. Parfaitement bifacial, Opus peut être équipé avec de tiroirs ou de portes abatantes, et se prête à l'ameublement des environnements domestiques ou professionnels.

ES Un sistema modular de librerías, totalmente de aluminio extruido, basado en la composición libre del cuadrado y del rectángulo como figuras modulares. Un concepto geométrico riguroso que permite la definición de librerías de varias dimensiones con un fuerte valor escenográfico. Perfectamente bifacial, puede equiparse con cajones o puertas abatibles, Opus se presta para equipar con personalidad el hogar o entornos profesionales.

RU Изготовленная полностью из экструдированного алюминия модульная система основана на свободной композиции квадрата и прямоугольника как модульных форм. Строгая геометрическая концепция позволяет компоновать элементы стеллажа различных размеров с ярко выраженной декоративной ценностью. Opus позволяет придать индивидуальность домашнему или профессиональному интерьеру благодаря двусторонней компоновке, которая может быть оснащена выдвижными ящиками или откидными дверцами.

汉语 这款模块化书柜系统全由挤出铝合金打造，设计理念基于将正方形和长方形的模块单元自由进行组合。这项设计通过本身严谨的几何概念发展出各式尺寸的书柜，每一件皆具有高度观赏价值。书柜的双面设计臻于完美，可加装收纳抽屉或翻门，为居家和办公环境营造个性品味。





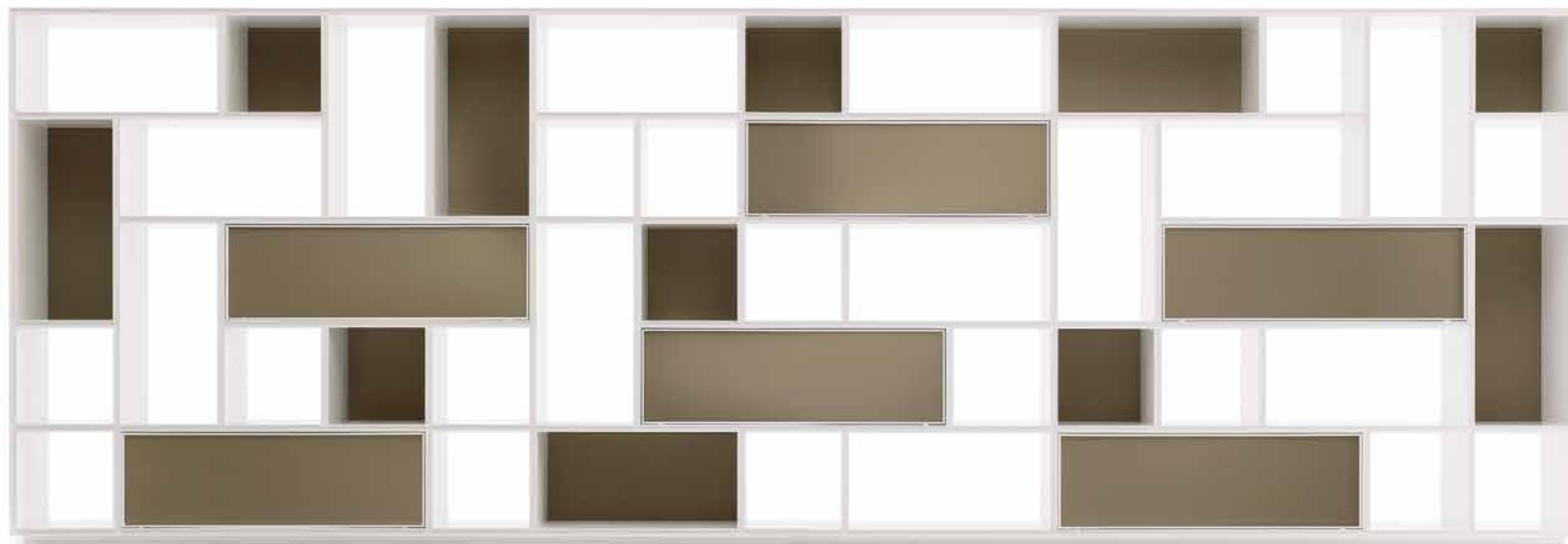



Structure: 14 brown
Glass back panel: 94 cacao reflex
W 1920 H 3860 D 386

EN A virtually endless modularity to be interpreted without limits. The Opus system offers the maximum dimensional freedom, in order to suggest new ways to design rooms and environments. The invisible nylon and fiber-glass cushioned joints ensure maximum stability even in very big compositions.

IT Una componibilità virtualmente infinita, da interpretare senza limiti. Il sistema Opus offre la massima libertà dimensionale, per suggerire nuove modalità di progetto degli ambienti. I giunti invisibili ad incastro in nylon e fibra di vetro garantiscono la massima stabilità anche in composizioni di grandi dimensioni.

DE Vollkommen unbegrenzte Kombinationsmöglichkeiten, die sich frei gestalten lassen. Das System Opus bietet eine optimale Freiheit in den Abmessungen und neue Möglichkeiten zur Raumgestaltung. Die unsichtbaren Steckverbindungen aus Nylon und Fiber-Glass garantieren höchste Stabilität bei sehr grossen Kompositionen auch.

FR Une componibilité virtuellement infinie, à interpréter sans limites. Le système Opus offre une liberté maximale de dimensions, afin de suggérer de nouvelles modalités de projet des espaces. Les joints invisibles à encastrer en nylon et fiber-glass garantissent la plus grande stabilité, même dans des compositions de grande dimension.

ES Una modularidad virtualmente infinita, que puede interpretarse sin límites. El sistema Opus ofrece la máxima libertad dimensional, para sugerir nuevas modalidades de proyecto en los ambientes. Las juntas invisibles de encastrer en nylon y fibre-glass garantizan la máxima estabilidad incluso en composiciones de grandes dimensiones.

RU Безграничная модульность, компоновка без ограничений. Система Opus предоставляет максимальную свободу размеров, предлагая новые способы оформления помещений. Невидимые межблочные соединения из нейлона и стекловолокна гарантируют максимальную устойчивость даже в композициях больших размеров.

汉语 模块化组合演绎出近乎无限的可能性。Opus 系统在尺寸上具有极高的自由度，为空间带来崭新的设计方法。对于大型组合柜，由尼龙材质和玻璃纤维制成的隐形连接件也能确保其最大的牢固度。



MODULARITY

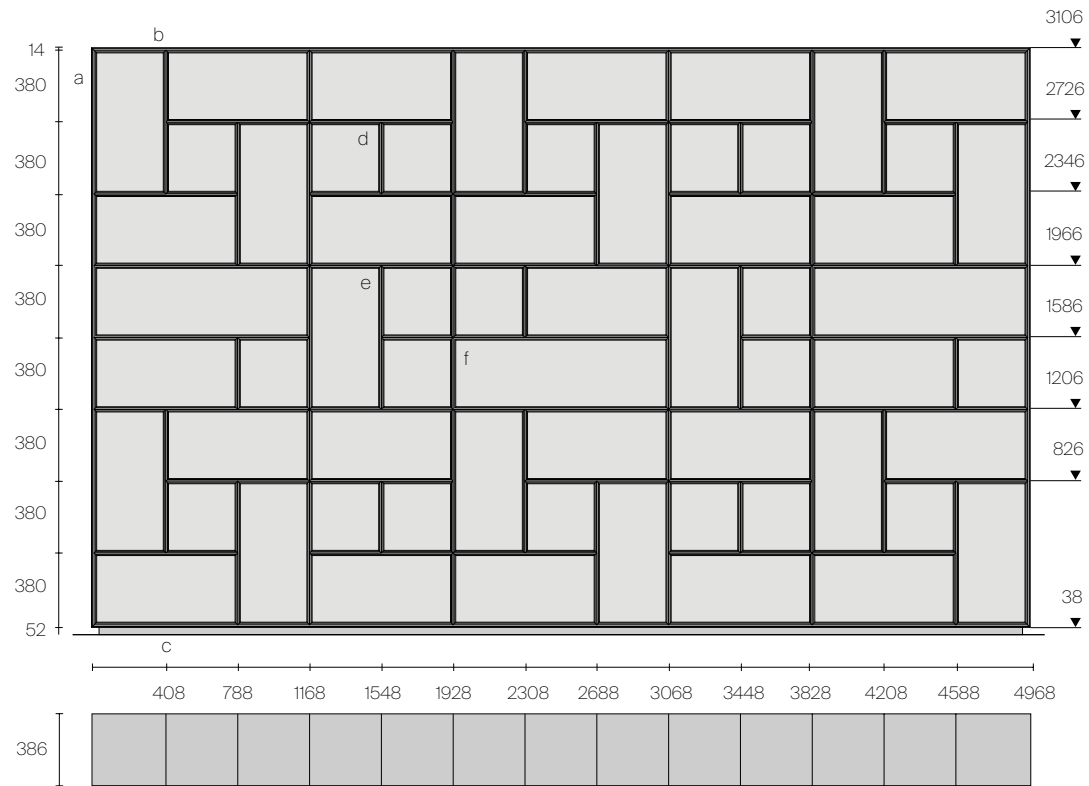

- a. Side panel
- b. Top
- c. Floor base
- d. Module 380 x 380
- e. Module 380 x 760
- f. Module 380 x 1140

TECHNICAL DESCRIPTION

EN Opus is by perfectly double-sided: it is made entirely in extruded aluminium, concealing any type of joint, and housing all the technical components necessary for assembly. It is infinitely modular in both height and width, with a square module measuring 38x38 cm and two rectangular modules (38x76 cm and 38x114 cm), with a single depth of 39 cm. The structure is available in five finishings: nero, brown, bianco latte, bronzo and platino. The accessories (backs, drawers, flap doors) are made of glass in a wide variety of finishings and colours.

IT Opus è caratterizzata da una perfetta bifaccialità: è realizzata in un unico estruso d'alluminio che nasconde alla vista qualunque tipo di giunzione, alloggiando al suo interno tutti i particolari tecnici necessari per l'assemblaggio. Componibile all'infinito in altezza e larghezza, dispone di un modulo quadrato da 38x38 cm e di due rettangolari (da 38x76 cm e da 38x114 cm), in un'unica profondità di 39 cm. La struttura è proposta cinque finiture: nero, brown, bianco latte, bronzo e platino. Gli accessori (schienali, cassetti, ante a ribalta) sono realizzati in vetro con una ricca varietà di finiture e colori.

DE Opus zeichnet sich durch eine perfekte Zweiteilung aus: Es besteht aus einem einzigen Aluminiumprofil, das jede Art von Verbindungen verbirgt, in seinem Inneren aber alle für die Montage erforderlichen technischen Details enthält. Es ist in Höhe und Breite stufenlos verstellbar und besteht aus einem quadratischen Modul von 38x38 cm und zwei rechteckigen Modulen (38x76 cm und 38x114 cm) mit einer Tiefe von 39 cm. Die Struktur wird in fünf Ausführungen angeboten: nero, brown, bianco latte, bronzo und platino. Das Zubehör (Rückwände, Schubladen, Klapptüren) ist aus Glas in einer Vielzahl von Ausführungen und Farben gefertigt.

FR Opus se caractérise par sa double face parfaite: elle est réalisée en un seul bloc d'aluminium extrudé dissimulant tout type de joint à la vue, et abritant à l'intérieur toutes les structures techniques nécessaires à l'assemblage. Modulable à l'infini, tant en hauteur qu'en largeur, elle comporte un module carré de 38x38 cm et deux rectangulaires (38x76 cm et 38x114 cm), pour une profondeur unique de 39 cm. Sa structure est disponible en cinq finitions: nero, brown, bianco latte, bronzo et platino. Les accessoires (fonds, tiroirs, portes basculantes) sont en verre et proposent une riche variété de finitions et de couleurs.

ES Opus se caracteriza por su estructura a doble cara perfecta: está fabricado en una extrusión única de aluminio que oculta a la vista cualquier tipo de junta, albergando en su interior todos los detalles técnicos necesarios para el montaje. Infinitamente modular en altura y anchura, cuenta con un módulo cuadrado de 38x38 cm y dos rectangulares (38x76 cm y 38x114 cm), en una única profundidad de 39 cm. La estructura está disponible en cinco acabados: nero, brown, bianco latte, bronzo y platino. Los accesorios (traseras, cajones, puertas abatibles) son de cristal y están disponibles con una gran variedad de acabados y colores.

RU Уникальная характеристика Opus — возможность двусторонней установки: он изготовлен из единого алюминиевого профиля, который скрывает от глаз любой тип соединения, а все технические детали, необходимые для сборки, скрыты внутри него. Бесконечные композиционные возможности по высоте и ширине обеспечиваются квадратным модулем 38x38 см и двумя прямоугольными 38x76 см и 38x114 см, глубины 39 см. Конструкция предлагается в пяти вариантах отделки: черном, коричневом, молочно-белом, бронзовом и платиновом. Комплектующие (ящики, откидные дверцы) изготовлены из стекла в богатом разнообразии отделки и цветов.

汉语 完美的双面设计为 Opus 的特色:由单一挤出铝合金打造,隐藏所有类型的结合点,所有必需的技术细节在安装过程中也以收入。模块化设计的高度和宽度能够无限延伸,可供选择的模块单元为 38x38 厘米的正方形和两款长方形(38x76 厘米和 38x114 厘米),深度皆为 39 厘米;有五种表面处理可供选择:黑、棕、牛奶白、黄铜和铂金。各式配件(背板、抽屉、翻门)以玻璃打造,附有丰富多样的表面处理和颜色可供选择。

COMPONENTS AND ACCESSORIES



1. Drawer unit with lacquered glass front. The drawers are entirely made of aluminium, with fully extractable runners and softclose mechanism.
2. The glass cabinets with flap door are in tempered glass with aluminium frame and they are equipped with exclusive invisible hinges.

Open module

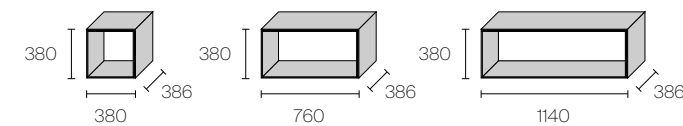

Module with drawers and back panel

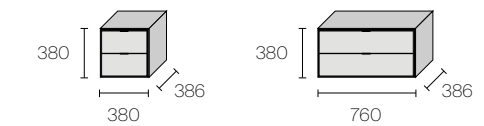

Synthetic leather mat for internal lining

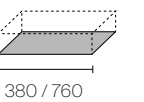

Open module with back panel

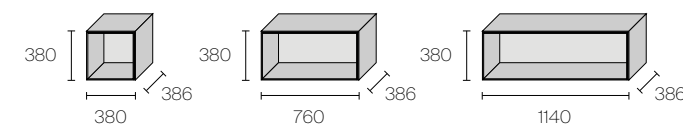

Module with flap door and back panel

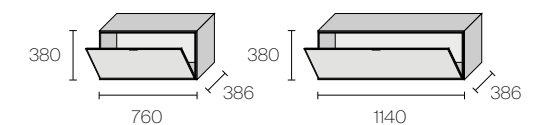

Battery led spotlight

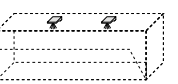

Aluminium top

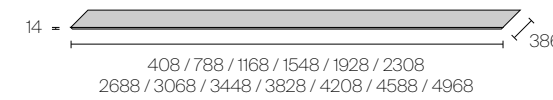

Glass top for compositions with height up to 1586

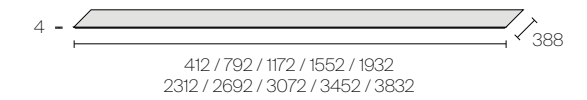

Aluminium base

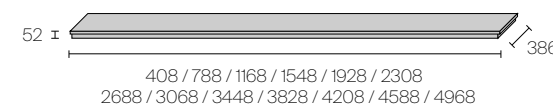

Aluminium side panel

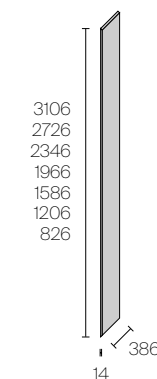

COMPOSITIONS

Height 831 mm

Composition with open modules

01

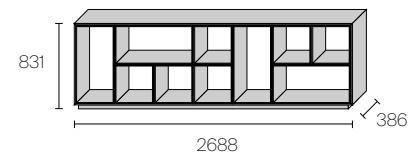

Composition with open modules and flap doors

25

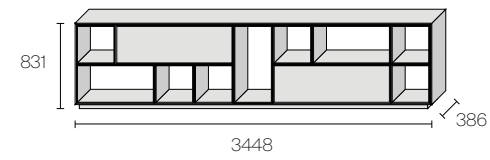

Height 1211 mm

Composition with open modules

02

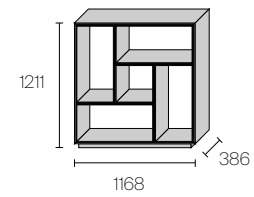

04

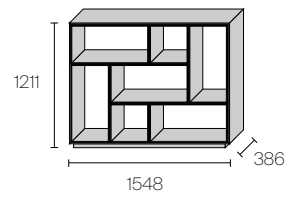

Composition with open modules and drawers

06

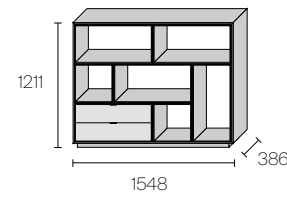

08

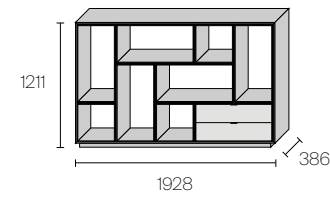

Composition with open modules with back panels and drawers

03

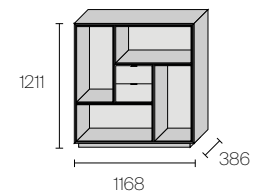

05

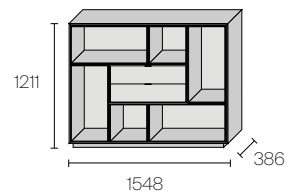

07

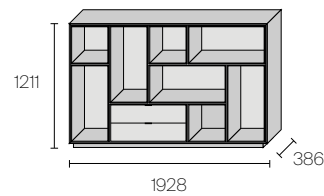

Height 1591 mm

Composition with open modules

09

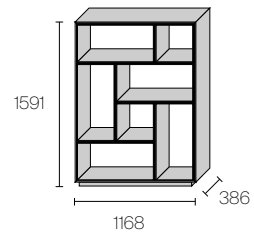

Composition with open modules and drawers

11

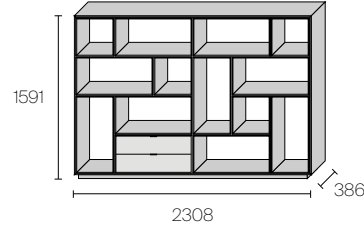

Composition with open modules with back panels and drawers

10

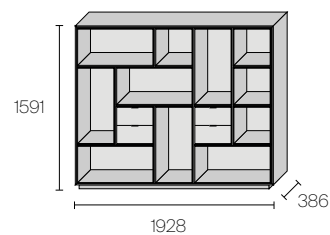

12

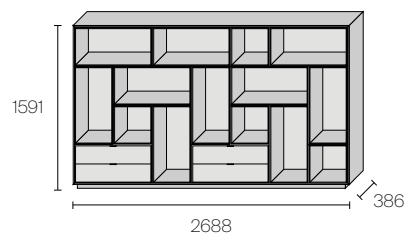

Height 1966 mm

Composition with open modules

14

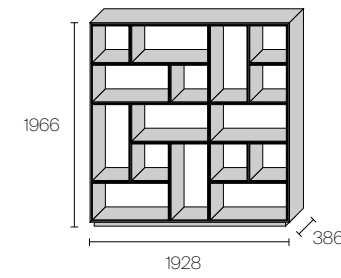

17

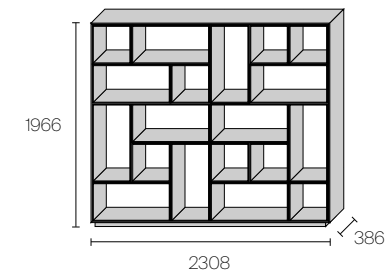

Composition with open modules and drawers

16

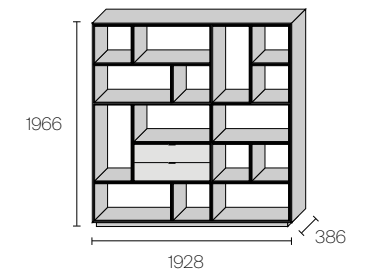

Composition with open modules with back panels and drawers

13

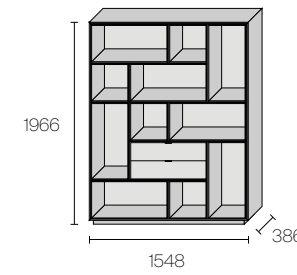

15

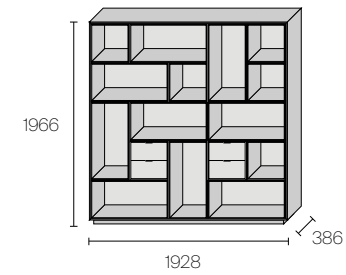

18

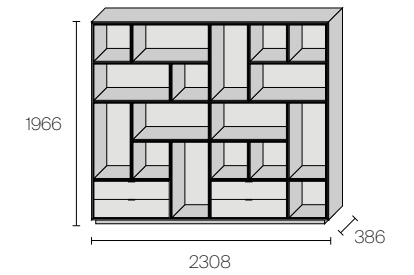

Composition with open modules with back panels and drawers, flap doors

21

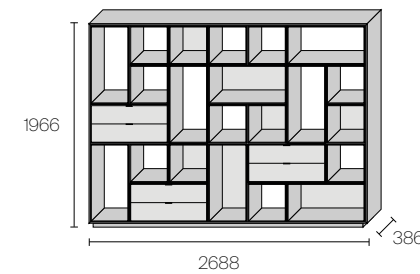

22

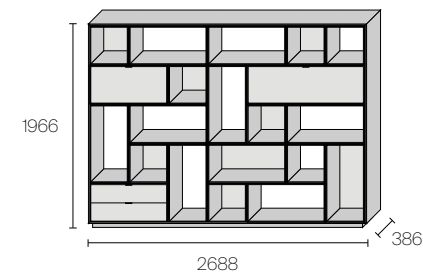

Composition with open modules with or without back panels and drawers, flap doors

23

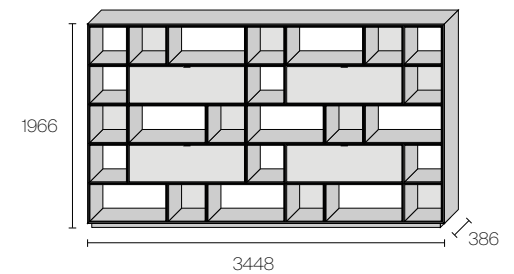

Height 2346 mm

Composition with open modules

19

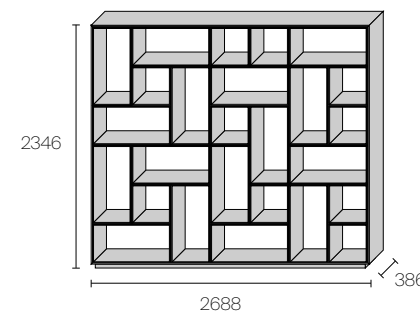

20

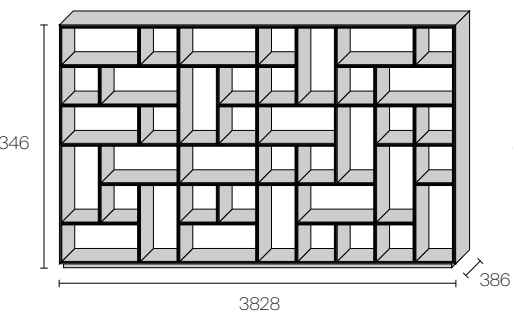

Composition open modules with back panels and flap doors

24

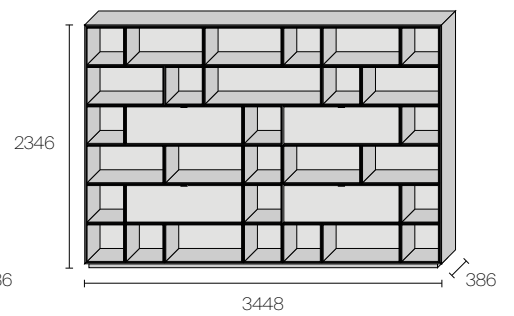

Structure, side panel and base

ALUMINIUM



Back panel and flap door

LACQUERED GLASS



METALIZED GLASS



REFLEX GLASS



SAHARA GLASS



TAIGA GLASS



SAHARA METALIZED GLASS

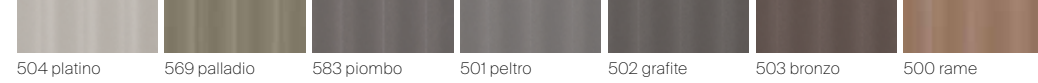

TAIGA METALIZED GLASS

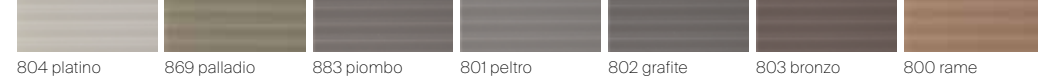

DIAMANTE GLASS



TRANSPARENT GLASS

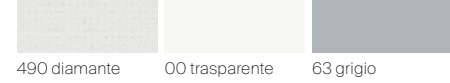

SATINATED GLASS

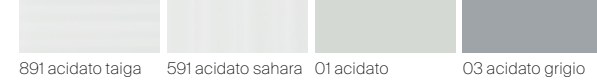

LITECH*



SAHARA WOOD*

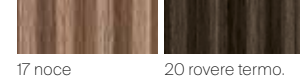

TAIGA WOOD*

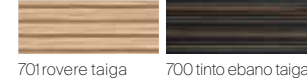

* Only available for back panel

Mat for internal lining

SYNTHETIC LEATHER



Top

MATT LACQUERED



LACQUERED METALIZED



ALUMINIUM



Drawer front

LACQUERED GLASS



METALIZED GLASS



REFLEX GLASS



SAHARA GLASS



TAIGA GLASS



SAHARA METALIZED GLASS

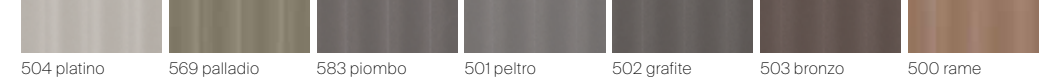

TAIGA METALIZED GLASS

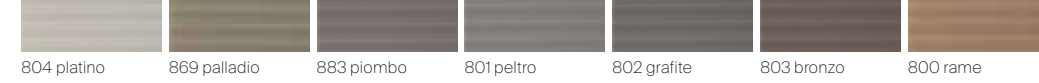

DIAMANTE GLASS



LITECH

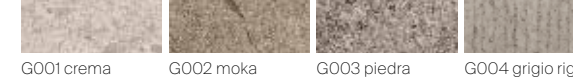

SAHARA WOOD

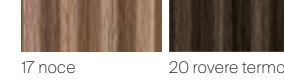

TAIGA WOOD

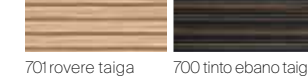

Drawer interior

INTERNAL MELAMINE





WIND IS THE ARCHETYPE OF THE BOOKCASE IN THE INTERPRETATION BY RIMADESIO: A MODULAR SYSTEM COMBINING AESTHETIC LIGHTNESS AND TECHNOLOGICAL INNOVATION. THE FOCUS OF THE PROJECT, ENTIRELY IN ALUMINIUM, IS REPRESENTED BY THE UNION BETWEEN EXTRUDED SHELVES AND DIE-CASTING UPRIGHTS, IN CENTRAL AND TERMINAL VERSIONS.

IT Wind è l'archetipo della libreria nell'interpretazione Rimadesio: un sistema modulare che coniuga leggerezza estetica e innovazione tecnologica. Il fulcro del progetto, interamente in alluminio, è rappresentato dall'unione fra ripiani estrusi e montanti in pressofusione, in versione centrale e terminale.

DE Wind steht für den Archetyp der Interpretation von Rimadesio: ein modulares System, welches ästhetische Leichtigkeit und technologische Innovation miteinander vereint. Im Mittelpunkt des Projekts steht die Einzigartigkeit der Verbindung aus stranggepressten Profilen der Fachböden und dem aus Aluminiumdruck gegossenen Pfosten. Sowohl in der vertikalen als auch der horizontalen.

FR Wind est l'archétype de la bibliothèque dans l'interprétation de Rimadesio: un système modulaire qui combine légèreté esthétique et innovation technologique. Caractéristique du projet, entièrement en aluminium, est représenté par l'union des étagères extrudés et des montants en moulage d'aluminium en version centrale ou terminale.

ES Wind es el arquetipo de la librería en la interpretación Rimadesio: un sistema modular que combina ligereza estética e innovación tecnológica. El enfoque del proyecto, por completo en aluminio, es representado por la unión entre los estantes extruidos y los montantes en inyección, en versión central y terminal.

RU Wind — это прообраз книжного стеллажа в новой интерпретации Rimadesio: модульная система, сочетающая эстетическую легкость и технологические инновации. Центральный элемент конструкции, полностью выполненной из алюминия, — сочетание экструдированных полок и литых стоек в центральной и боковых секциях.

汉语 Wind 为 Rimadesio 对书柜设计原型的重新演绎：它是一套将轻盈美学和技术创新相结合的模块化系统。其设计重点为全铝合金，由挤压工艺制成的层板和铝锭压铸成型的立柱组成，有中央型和末端型两种款式可选。



EN The vertical modularity of Wind is based on nylon fibre connection joints which are inserted into the uprights guaranteeing maximum stability. The six widths of the Wind bookcase (600, 800, 1000, 1200, 1400, 1600 mm) enable infinite modularity with a 200 mm module. The final element in each composition is the lacquered and laminated MDF top covered with a double sheet of aluminium, or the upper bracket in die-cast aluminium for the wall-mounted version. Wind becomes even more versatile with the upright for multiple heights, which enables the composition of double-height compartments even in the side columns, and an equipped TV compartment.

IT La componibilità verticale di Wind avviene tramite giunti di collegamento in nylon fibra che si innestano nei montanti e garantiscono la massima stabilità. Le sei larghezze della libreria Wind (600, 800, 1000, 1200, 1400, 1600 mm) permettono una componibilità infinita a modulo 200 mm. Elemento terminale di ogni composizione è il top laccato e stratificato in mdf rivestito da una doppia lastra di alluminio, oppure la staffa superiore in alluminio pressofuso per la versione a parete. Wind diventa ancora più versatile grazie al montante per altezze multiple, che permette la composizione di vani a doppia altezza anche nelle colonne laterali, e di un vano TV attrezzato.

DE Die vertikale Modularität von Wind wird durch Verbindungen aus Nylonfasern erreicht, die in die Pfosten eingreifen und maximale Stabilität garantieren. Die sechs Breiten des Bücherregals Wind (600, 800, 1000, 1200, 1400, 1600 mm) ermöglichen eine unbegrenzte Modularität mit 200-mm-Modulen. Das Abschlusselement jeder Komposition ist die lackierte und geschichtete MDF-Platte, die mit einem doppelten Aluminiumblech überzogen ist, oder die obere Halterung aus Aluminiumdruckguss für die wandmontierte Version. Wind wird noch vielseitiger dank der Multi-Height-Basis, die die Zusammenstellung von Fächern in doppelter Höhe auch in den Seitensäulen ermöglicht, und einem ausgerüsteten TV-Abteil.

FR Le secret de la grande modularité de Wind sont les joints de raccordement en fibre de nylon qui se fixent dans les montants et garantissent une stabilité maximale. Les six largeurs de la bibliothèque Wind (600, 800, 1000, 1200, 1400, 1600 mm) permettent une modularité infinie grâce aux modules de 200 mm. Chaque composition est finalisée par un plateau en MDF laqué et stratifié recouvert d'une double feuille d'aluminium, ou par le support supérieur en aluminium moulé sous pression pour la version murale. Wind devient encore plus polyvalente grâce au montant pour hauteurs multiples, qui permet de créer des compartiments à double hauteur, y compris sur les colonnes latérales, outre un compartiment TV équipé.

ES La modularidad vertical de Wind se logra mediante el uso de juntas de conexión de fibra de nailon, que se acoplan en los montantes y garantizan la máxima estabilidad. Las seis anchuras disponibles para la librería Wind (600, 800, 1000, 1200, 1400, 1600 mm) permiten una modularidad infinita en un módulo de 200 mm. El elemento final de cada composición es el top lacado y laminado en MDF revestido con una hoja doble de aluminio, o el soporte superior de aluminio fundido a presión para la versión a pared. Wind se vuelve aún más versátil gracias al montante para múltiples alturas, que permite la composición de compartimentos de doble altura incluso en las columnas laterales, y un compartimento TV equipado.

RU Вертикальная модульность Wind достигается благодаря нейлоновым волокнистым соединениям, которые входят в стойки и гарантируют максимальную устойчивость. Шесть вариантов ширины книжного шкафа Wind (600, 800, 1000, 1200, 1400, 1600 мм) допускают бесконечную модульность с Шагом в 200 мм. Завершающий элемент каждой композиции — лакированный и многослойный верх из мдф, покрытый двойным алюминиевым листом, или верхний кронштейн из литого алюминия для настенной версии. Wind становится еще более универсальным с нишами двойной высоты или для телевизора, в том числе в крайних секциях.

汉语 尼龙纤维制的连接件实现了Wind书柜的垂直模块化，其在立柱中互相啮合并确保最大牢固度。Wind书柜共有六种宽度可选（600, 800, 1000, 1200, 1400, 1600毫米），在以200毫米为单元的情况下实现无限种模块组合。每种组合的末端组合件台面皆为烤漆处理，并以覆上双层铝板的MDF密度板进行层压；墙面的版本则为压铸铝合金制成的顶部托架。因多重高度的立柱，Wind的用途得更加广泛，除了能够在侧柱内配置双倍高度的空间，亦能留出装设电视的空间。



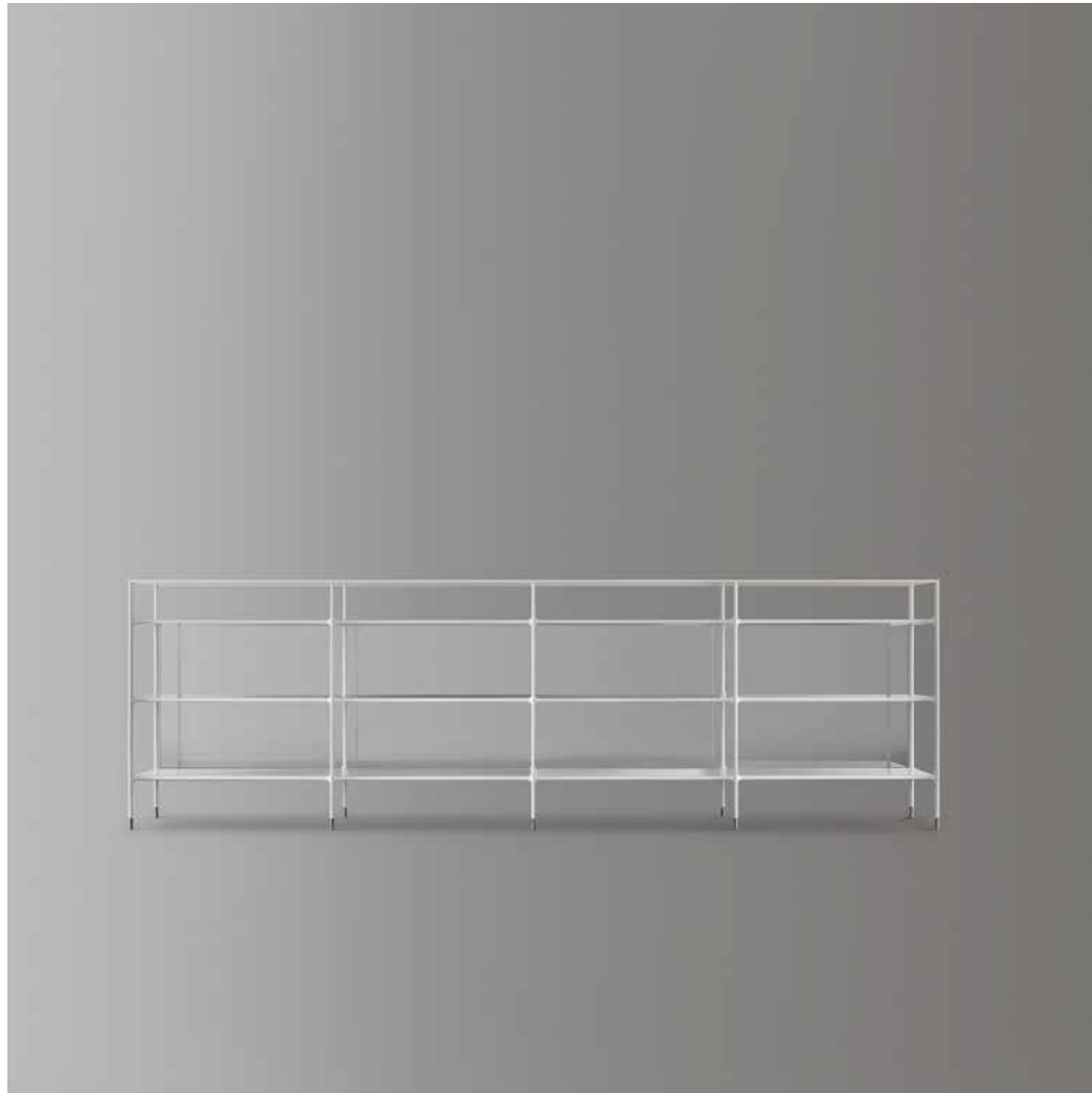

FREESTANDING BOOKCASE
Structure: 16 bianco latte
Glass back panel: 01 acidato
W 4020 H 1202 D 400

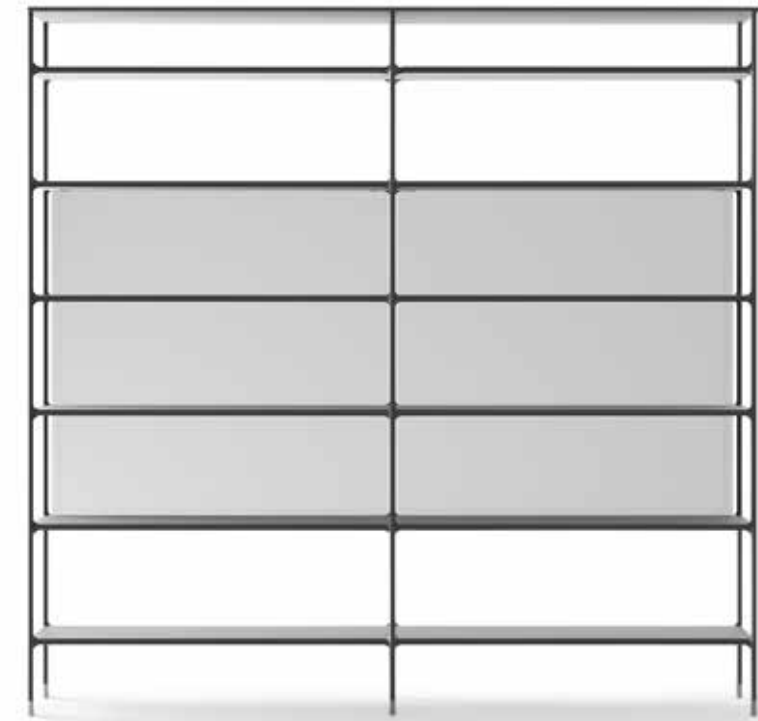

FREESTANDING BOOKCASE
Structure: 13 nero
Glass back panel: 63 grigio trasparente
W 2020 H 2342 D 400

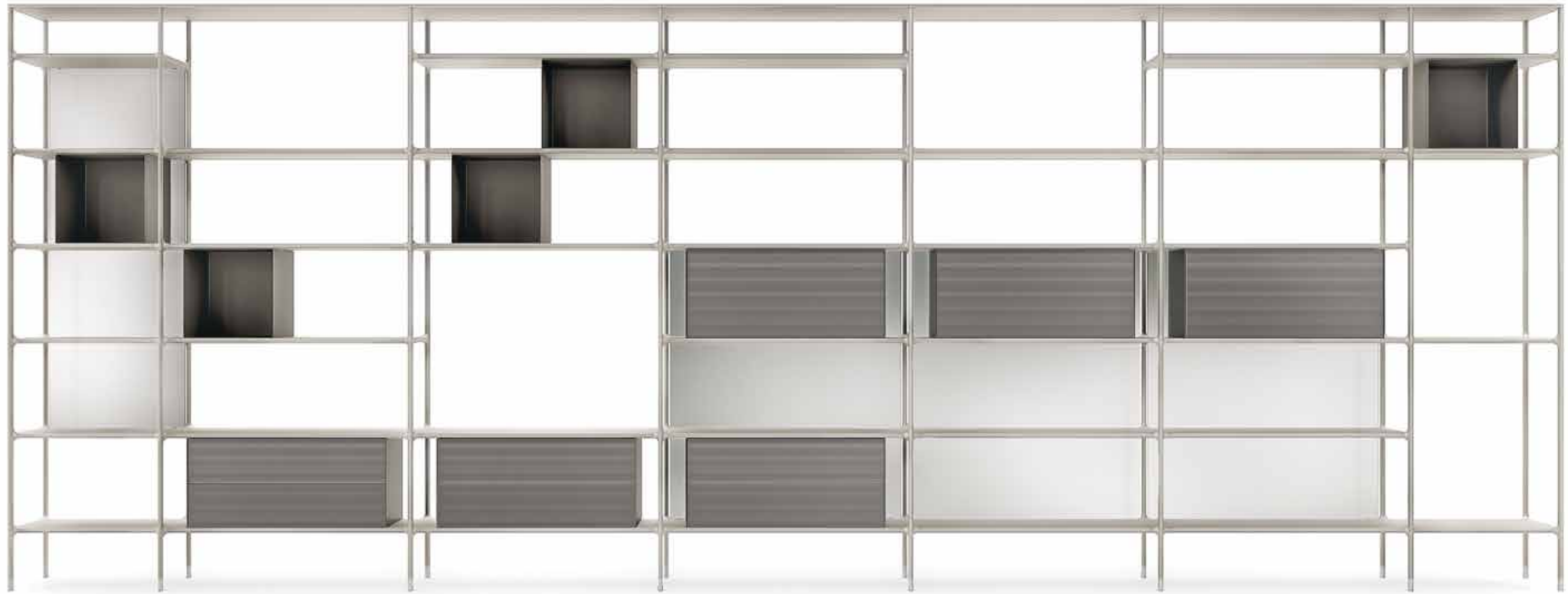

FREESTANDING BOOKCASE
Structure: 304 platino
Drawer and flap door fronts: 801 peltro taiga
Open modules: 301 peltro
Glass back panel: 63 grigio trasparente
W 6220 H 2343 D 400





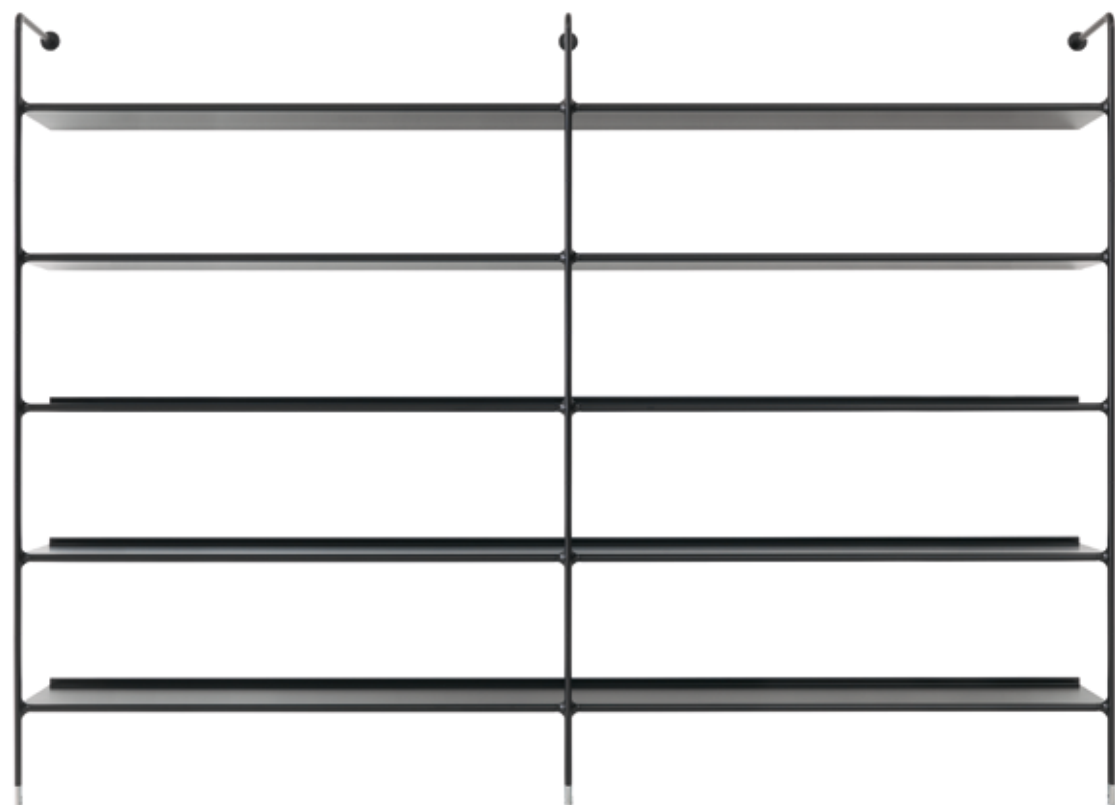

WALL BOOKCASE
Structure: 13 nero
W 2420 H 2018 D 400



WALL BOOKCASE
Structure: 16 bianco latte

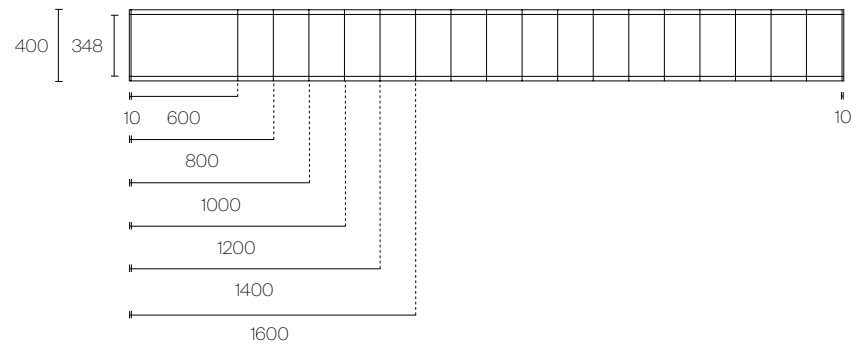
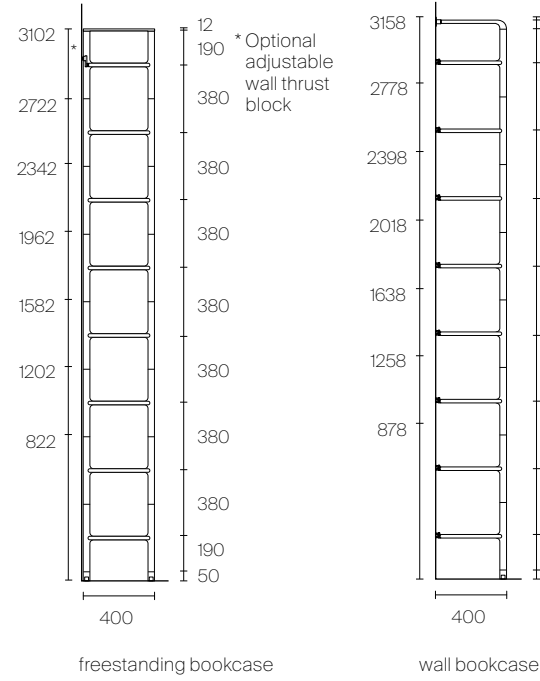
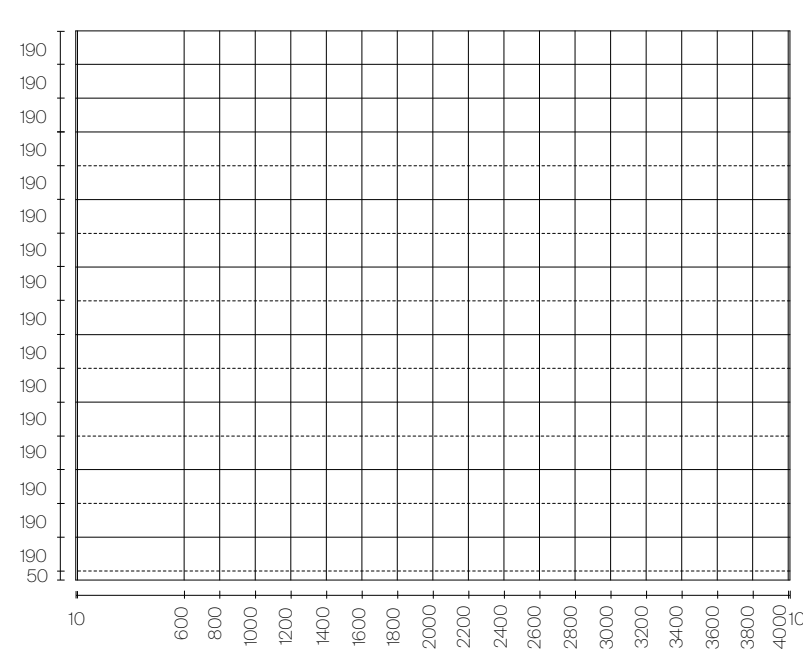

Laminated lacquered mdf top, covered by a double aluminium plate



Aluminium shelf with extruded closing profiles

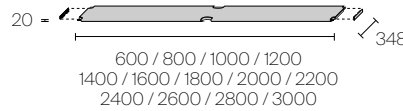

Optional adjustable wall thrust block

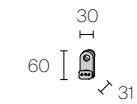

Back panel

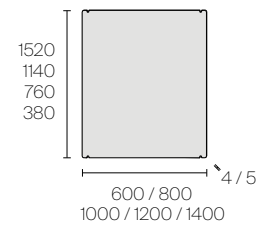

Terminal and central uprights



Upright for double-height modules



Upper wall bracket

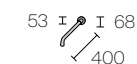

Open module in lacquered steel

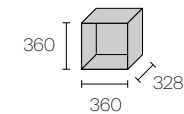

Decoder holder for TV compartment

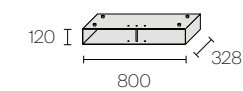

Drawer unit with 2 push drawers

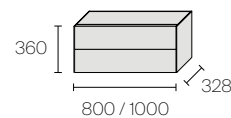

Synthetic leather mat for internal lining

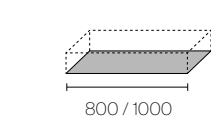

Flap door unit

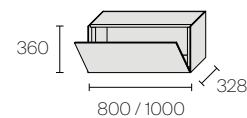

Bar unit with flap door

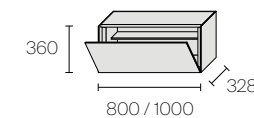

Battery led spotlight

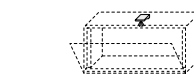

1



2



3



4



5



6

1. Unit with 2 push drawers with fully extractable runners. Structure and profiles 14 brown, glass 141 pepe opaco, drawer interior UB09, dark grey aluminium drawer runners.
2. Unit with 2 push drawers with fully extractable runners. Structure and profiles 304 platino, glass 141 pepe opaco, drawer interior UB07, light grey aluminium drawer runners.
3. Bar unit with flap door. Structure and profiles 14 brown, glass 141 pepe opaco, unit interior UB09, glass internal shelf O5 trasparente extrachiaro.
4. Bar unit with flap door. Structure and profiles 304 platino, glass 141 pepe opaco, unit interior UB07, glass internal shelf O5 trasparente extrachiaro.
5. Detail of upper wall bracket and wall aluminium shelf in extruded aluminium profile.
6. The back panel in tempered glass is equipped with an exclusive hanging system, and it is available in a wide range of finishings.

Structure, top, shelf and bracket

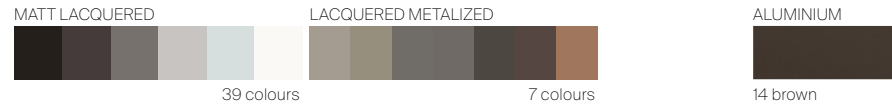

Back panel



Drawer and flap door profiles

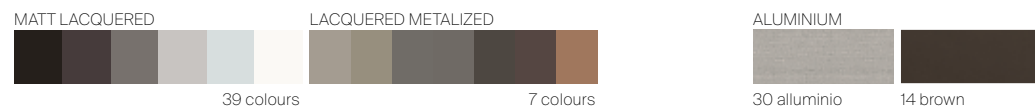

Flap door unit and unit with push drawer

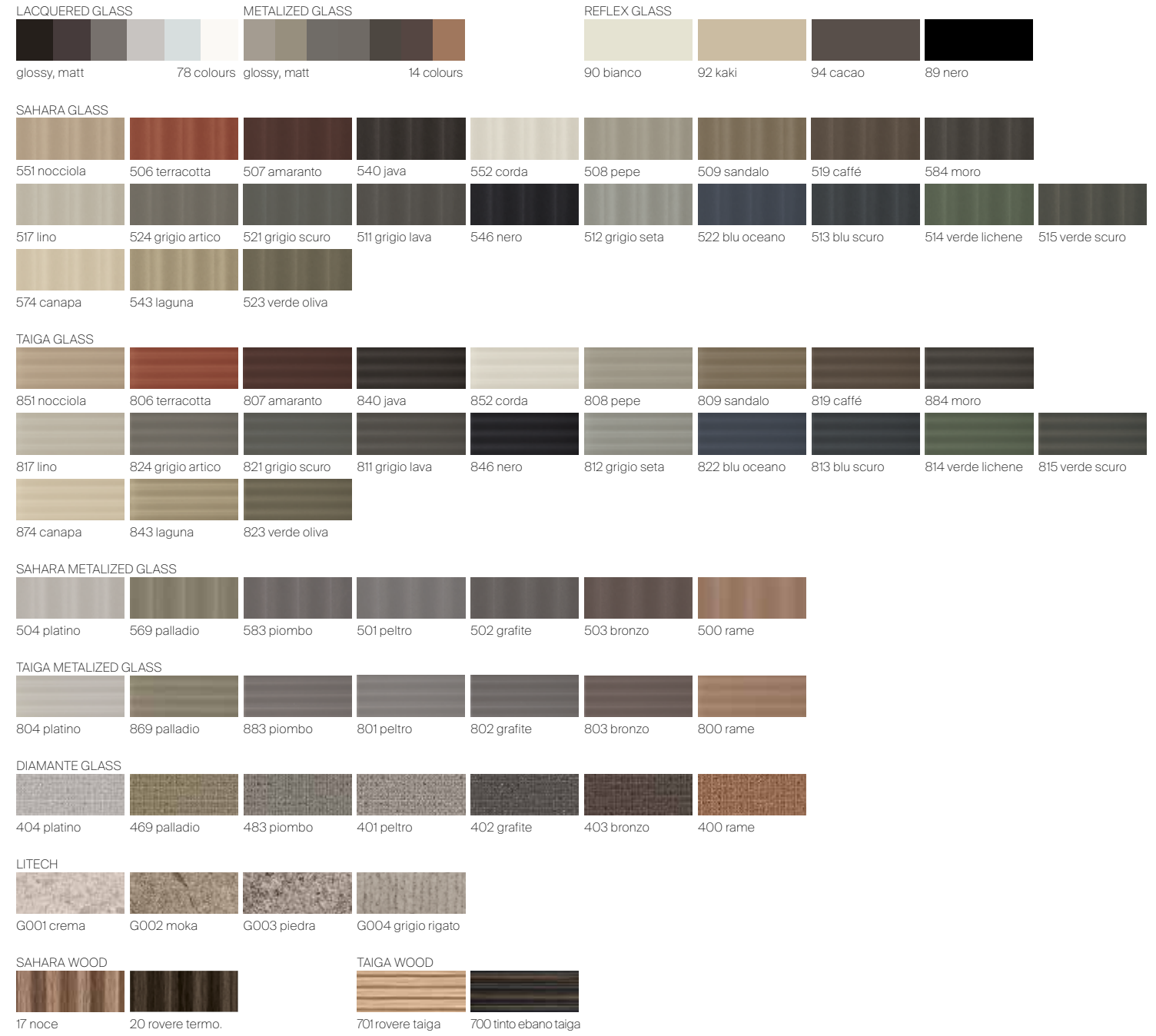

Mat for internal lining

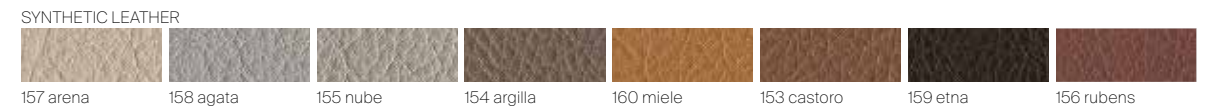

Internal back panel for bar unit



Internal shelf for bar unit

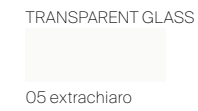

Unit interior

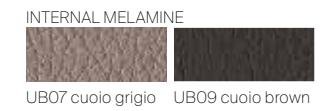

STORAGE UNIT SYSTEMS

92 RIALTO, 120 ALAMBRA, 176 ABACUS LIVING

STORAGE UNIT SYSTEMS



THE RIALTO COLLECTION INCLUDES FURNITURE WITH A STRONG PERSONAL AND RECOGNISABLE CHARACTER, ALWAYS IN LINE WITH THE RIMADESIO PHILOSOPHY OF DESIGNING AND MANUFACTURING PRODUCTS WITH AN ESSENTIAL AND CONTEMPORARY AESTHETIC LINE MEANT TO LAST.

IT La collezione Rialto racconta di arredi dal forte carattere personale e riconoscibile, sempre coerente con la filosofia Rimadesio di progettare e realizzare prodotti dalla linea estetica essenziale e contemporanea, destinati a durare nel tempo.

DE Die Rialto-Kollektion besteht aus Möbeln mit einer starken Persönlichkeit mit hohem Wiedererkennungswert, immer im Einklang mit der Rimadesio-Philosophie, Produkte mit einer essenziellen und zeitgemäßen ästhetischen Linie zu entwerfen und herzustellen, die für eine lange Lebensdauer bestimmt sind.

FR La collection Rialto réunit des meubles de caractère, immédiatement identifiables, toujours cohérents avec la philosophie Rimadesio: concevoir et réaliser des produits avec des lignes épurées, contemporaines et conçu pour durer dans le temps.

ES La colección Rialto se compone de muebles con un fuerte carácter personal y reconocible, siempre coherente con la filosofía de Rimadesio de diseñar y fabricar productos con una línea estética esencial y contemporánea, destinados a perdurar en el tiempo.

RU Коллекция Rialto – это мебель с ярко выраженным индивидуальным и узнаваемым характером, всегда согласующаяся с философией Rimadesio по проектированию и производству продуктов с существенной и современной эстетикой, предназначенной для использования в течение долгого времени.

汉语 Rialto 系列家具十分具识别度且带有强烈个性，始终契合 Rimadesio 的品牌理念，产品的设计制作以基本现代的美学线条勾勒且经久耐用。



SIDEBOARD
Structure: 304 platino
Doors: 701 rovere taiga
Top: 67 riflettente chiaro
Lower top: 711 rovere
Internal shelf: 63 grigio trasparente
Natural light wood internal finishing

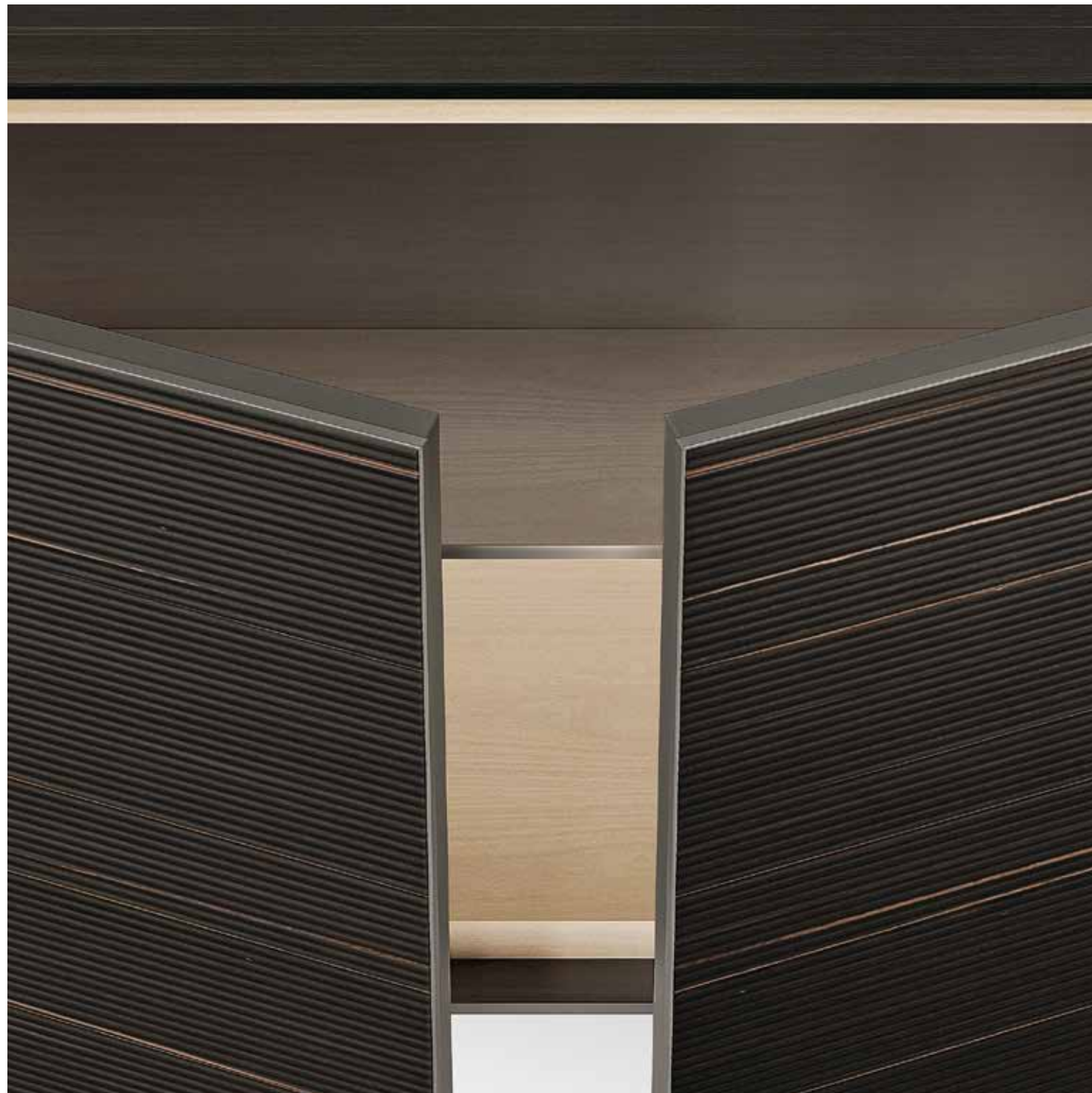

SIDEBOARD
Structure: 83 piombo
Doors: 700 tinto ebano taiga
Glass top: 67 riflettente chiaro
Lower top: 710 tinto ebano
Internal shelf: 63 grigio trasparente
Natural light wood internal finishing
H 810 W 2279 D 472

EN The Rialto collection is made of various elements characterised by a bridge structure in extruded, welded metal that suspends the central cabinets and the support top. The use of natural light wood for the cabinets in the sideboard, console and bar unit is a break with tradition, conferring prestige, elegance and quality, taking inspiration from the haute cabinetmaking techniques of the past.

IT La collezione Rialto è composta da diversi elementi caratterizzati da una struttura a ponte in metallo estruso e saldato che sospende i contenitori centrali e il top di appoggio. Inedito l'utilizzo del legno chiaro naturale per gli interni dei contenitori della madia, della consolle e del mobile bar, a conferire prestigio, eleganza e qualità prendendo ispirazione dalle tecniche di alta ebanisteria di un tempo.

DE Die Rialto-Kollektion besteht aus mehreren Elementen, die sich durch eine stranggepresste und geschweißtes Brück Struktur aus Metall auszeichnen, an der die zentralen Behältereinheiten und die Platte aufgehängt sind. Außergewöhnlich ist die Verwendung von natürlichem, hellem Holz für das Innere des Schrankes, der Konsole und des Barschranks. Dies verleiht Prestige, Eleganz und Qualität, inspiriert von den Tischlertechniken vergangener Zeiten.

FR La collection Rialto comprend différents éléments, caractérisés par une structure en forme de pont en métal extrudé et soudé, d'où sont suspendus les rangements centraux et le plateau de support. L'utilisation inédite de bois clair naturel pour l'intérieur des éléments de rangement du bahut, de la console et du meuble bar, confère prestige, élégance et qualité, en s'inspirant des techniques de la haute ébénisterie d'autrefois.

ES La colección Rialto está compuesta por varios elementos, se caracteriza por una estructura puente, realizada en metal extrusionado y soldado, que suspende los contenedores centrales y el top de apoyo. El inusual empleo de madera clara natural para el interior del aparador, la consola y el mueble bar aporta prestigio, elegancia y calidad, y está inspirado en las técnicas de ebanistería de antaño.

RU Коллекция Rialto состоит из шести элементов линейка характеризуется мостовым элементом изготовленным из экструдированного и сварного алюминия, на котором подвешиваются центральные контейнеры и опорная верхняя часть. Необычным является использование натурального светлого дерева внутри тумбы, консоли и барного шкафа, что придает престиж, элегантность и качество, вдохновленные техникой краснодеревщиков прошлых лет.

汉语 Rialto 系列由多项组合件构成，设计特色为挤出焊接金属的桥状组合件，其可悬吊中央的收纳空间和支撑台面。餐边柜、长桌和酒吧柜的内部收纳空间采用新型天然浅色木材，带有尊贵典雅的气息与细腻的品质，灵感源自过往的高级雕刻镶嵌橱柜的制作工艺。



CONSOLE
Structure: 83 piombo
Drawer fronts and lower top: 710 tinto ebano
Glass top: 63 grigio trasparente
H 790 W 1887 D 412

BAR CABINET
Structure: 83 piombo
Doors: 700 tinto ebano taiga
Glass top: 127 piombo opaco
H 1563 W 1073 D 470

SIDEBOARD
Structure: 83 piombo
Doors: 700 tinto ebano taiga
Glass top: 67 riflettente chiaro
Lower top: 710 tinto ebano
H 810 W 2279 D 472



SIDEBOARD
Structure: 302 grafite
Doors: 813 blu scuro taiga
Glass top: 67 riflettente chiaro
Lower top: 135 grafite opaco
H 810 W 2279 D 472



CONSOLE
Structure: 301 peltro
Drawer front and lower top: 710 tinto ebano
Glass top: 63 grigio trasparente
H 790 W 1887 D 412

In this photo
Wall panelling system: Modulor

EN The drawer fronts of the Rialto console have an exclusive seamless aluminium perimeter edge made using a folding system, common to all the elements in the collection. The interiors are in light wood and the bases of the drawers are in synthetic leather, available in the 8 exclusive colours of the Rimadesio sample collection.

IT Il frontale dei cassetti della consolle Rialto ha un esclusivo profilo perimetrale in alluminio senza interruzione realizzato con lavorazione folding, comune a tutti gli elementi della collezione. Gli interni sono in legno chiaro e i fondi dei cassetti in similpelle, disponibile negli 8 esclusivi colori del campionario Rimadesio.

DE Die Schubladenfront der Rialto-Konsole hat ein einzigartiges, durchgehendes Aluminiumprofil, das mit einer Faltechnik hergestellt wird, die allen Elementen der Kollektion gemeinsam ist. Die Innenausstattung ist aus hellem Holz und die Schubladenböden sind mit Kunstleder bezogen, das in den 8 exklusiven Rimadesio-Musterfarben erhältlich ist.

FR La façade des tiroirs de la consolle Rialto présente un profil périmétrique exclusif en aluminium sans soudure, réalisé à travers un travail de pliage, commun à tous les éléments de la collection. L'intérieur est en bois clair et le fond des tiroirs en similicuir, disponibles dans les 8 couleurs exclusives du collection Rimadesio.

ES El frente de los cajones de la consola Rialto cuenta con un exclusivo perfil perimetral continuo de aluminio, realizado con una elaboración plegable, común a todos los productos de la colección. Los interiores son de madera clara y los fondos de los cajones de simil cuero, disponibles en los ocho exclusivos colores del muestrario de Rimadesio.

RU Фасад ящика консоли Rialto согнутым по углам с помощью технологии «фолдинг» — общей для всех элементов коллекции. Внутренняя отделка выполнена из светлого дерева, а дно ящиков из искусственной кожи, доступной в 8 эксклюзивных цветах Rimadesio.

汉语 Rialto 系列长桌的抽屉正面以铝合金打造，通过折边工艺勾勒出特殊的连续边线轮廓，该轮廓为本系列所有产品共有的设计特征。内部则由浅色木材打造，底部选用仿真皮革，在 Rimadesio 的样品集中共有 8 种独家颜色可供选择。

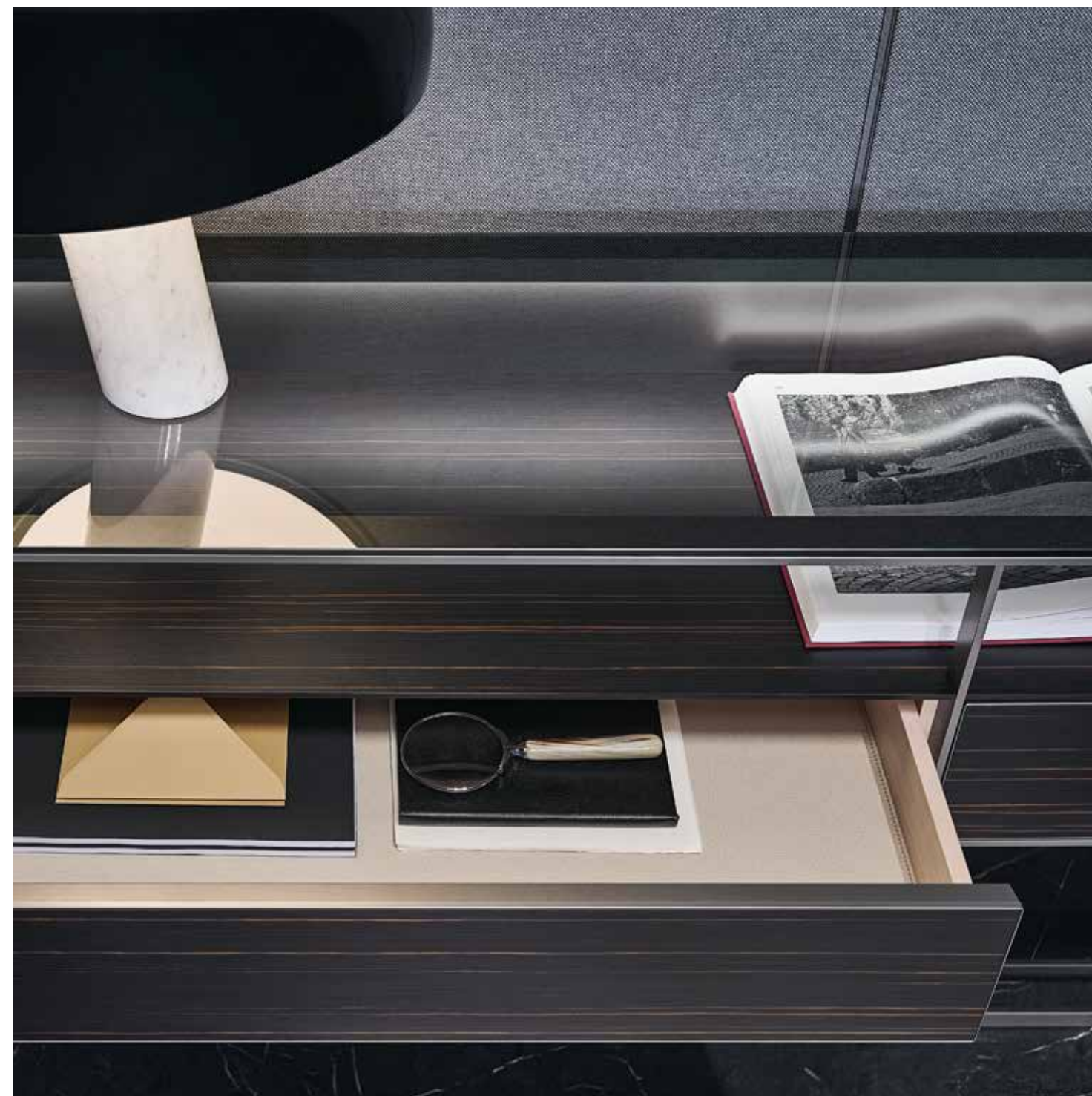

CONSOLE
Structure: 301 peltro
Drawer front and lower top: 710 tinto ebano
Glass top: 63 grigio trasparente
Drawers internal lining in synthetic leather: 157 arena
H 790 W 1887 D 412



BAR CABINET
Structure: 301 peltro
Doors: 17 noce sahara
Glass top: 134 peltro opaco
H 1563 W 1073 D 470



SIDEBOARD
Structure: 304 platino
Doors: 508 pepe sahara
Glass top: 67 riflettente chiaro
Glass lower top: 141 pepe opaco
H 810 W 2279 D 472



BAR CABINET
Structure: 75 amaranto
Doors: 807 amaranto taiga
H 1563 W 1073 D 470

In this photo
Wall panelling system: Modulor

EN The Rialto bar unit features light wood interiors and a mirror back panel. The shelves and drawers can be in glass or synthetic leather in the 8 finishings available in the sample collection. Optional are the LED lighting systems with touch switch or integrated electrical power strip. The interior includes a glass shelf and a cabinet in natural light wood with a top covered in synthetic leather. The cabinet is composed of side shelves and three drawers with synthetic leather bases and handles, available in all the colours of the sample collection. The external LED lighting comes with a touch switch, while the interior is lit by a twin spotlight with motion sensor.

IT Rialto mobile bar presenta interni in legno chiaro e schienale a specchio. I ripiani e i cassetti possono essere in vetro o in similpelle nelle 8 finiture disponibili a campionario. Opzionabili i sistemi di illuminazione a LED con accensione a sfioramento o la multipresa elettrica integrata. L'interno prevede un ripiano in vetro e un contenitore in legno chiaro naturale con top rivestito in similpelle. Il contenitore è composto da ripiani laterali e tre cassetti con fondo e maniglie in similpelle, disponibili in tutti i colori previsti in campionario. L'illuminazione esterna è a led con accensione a sfioramento, mentre l'interno è illuminato da un faretto a due ottiche con sensore di presenza.

DE Der Barschrank Rialto ist mit hellem Holz ausgestattet und hat eine verspiegelte Rückseite. Einlegeböden und Schubladen können aus Glas oder mit Kunstleder in den 8 im Musterbuch verfügbaren Ausführungen hergestellt werden. Optional erhältlich sind LED-Beleuchtungssysteme mit Touch-Einschaltung oder die integrierte Steckdosenleiste. Die Innenausstattung besteht aus einer Glasablage und einer Ablage aus hellem Naturholz mit einer kunstlederbezogenen Platte. Die Aufbewahrungseinheit umfasst seitliche Regale und drei Schubladen mit Kunstlederboden und Griffen, erhältlich in allen Farben der Musterkollektion. Als Außenbeleuchtung kommen LED-Lampen mit Touch-Einschaltung zum Einsatz, während der Innenraum von einem zweifach optischen Scheinwerfer mit Anwesenheitssensor beleuchtet wird.

FR Le meuble bar Rialto affiche un intérieur en bois clair et un fond réfléchissant. Les étagères et les tiroirs peuvent être réalisés en verre ou en similicuir, dans les 8 finitions disponibles dans la collection. En option: systèmes d'éclairage LED avec interrupteur tactile ou multiprise électrique intégrée. L'intérieur comprend une étagère en verre et un élément de rangement en bois clair naturel, avec plateau recouvert de similicuir. L'élément de rangement est composé de tablettes latérales et de trois tiroirs avec fond et poignées en similicuir, disponibles dans toutes les couleurs de la collection. L'éclairage extérieur LED est doté d'un interrupteur tactile, tandis que l'intérieur est éclairé par un spot à deux lentilles avec capteur de présence.

ES El mueble bar Rialto presenta un interior de madera clara y una parte trasera de espejo. Los estantes y cajones pueden ser de cristal o en simil cuero de los ocho acabados disponibles en el muestrario. De manera opcional, puede incluir sistemas de iluminación LED opcionales con interruptor táctil o regleta integrada. El interior incluye una balda de cristal y un contenedor de madera natural clara con tapa revestida en simil cuero. El contenedor se compone de baldas laterales y tres cajones con fondo y tiradores en simil cuero, disponibles en todos los colores incluidos en el muestrario. La iluminación exterior con LED cuenta con interruptor táctil, mientras que el interior está iluminado por un foco de dos ópticas con sensor de presencia.

RU Внутренняя отделка барного шкафа Rialto выполнена из светлого дерева, а задняя стенка — зеркальная. Полки и ящики могут быть выполнены из стекла или искусственной кожи в 8 вариантах отделки, представленных в книге образцов. В качестве опции предлагаются светодиодные светильники с сенсорным включением или Блок розеток. Внутри размещена стеклянная полка и Блок для хранения из натурального светлого дерева с верхней частью, обтянутой искусственной кожей. Отделение для хранения состоит из боковых полок и трех выдвижных ящиков с дном и ручками, выполненными из искусственной кожи, доступными во всех цветах из коллекции образцов. Внешнее освещение — светодиодное с сенсорным включением, а внутренняя часть освещается двумя оптическими точечными светильниками с датчиком присутствия.

汉语 Rialto 酒吧柜的内部以浅色木材打造并搭配镜面背板。层板和抽屉可采用玻璃或仿真皮革制作，样品集中有 8 种表面处理可供选择。亦可选配带轻触开关或集成电源插座的 LED 照明系统。内部为一块玻璃制层板和一件天然浅色木材打造的收纳空间，台面以仿真皮革包覆。该收纳空间由侧方层板和三个深抽屉组成，把手以仿真皮革包覆，在样品集中的所有颜色皆可供选择。外部照明为带轻触开关的 LED 灯，内部照明采用配有动作传感器的双聚光灯。



BAR CABINET
Structure: 75 amaranto
Doors: 807 amaranto taiga
Glass top: 129 amaranto opaco
Shelf: 63 grigio trasparente
Internal back panel: 68 specchio grigio
Internal in natural light wood
and synthetic leather 157 arena
H 1563 W 1073 D 470

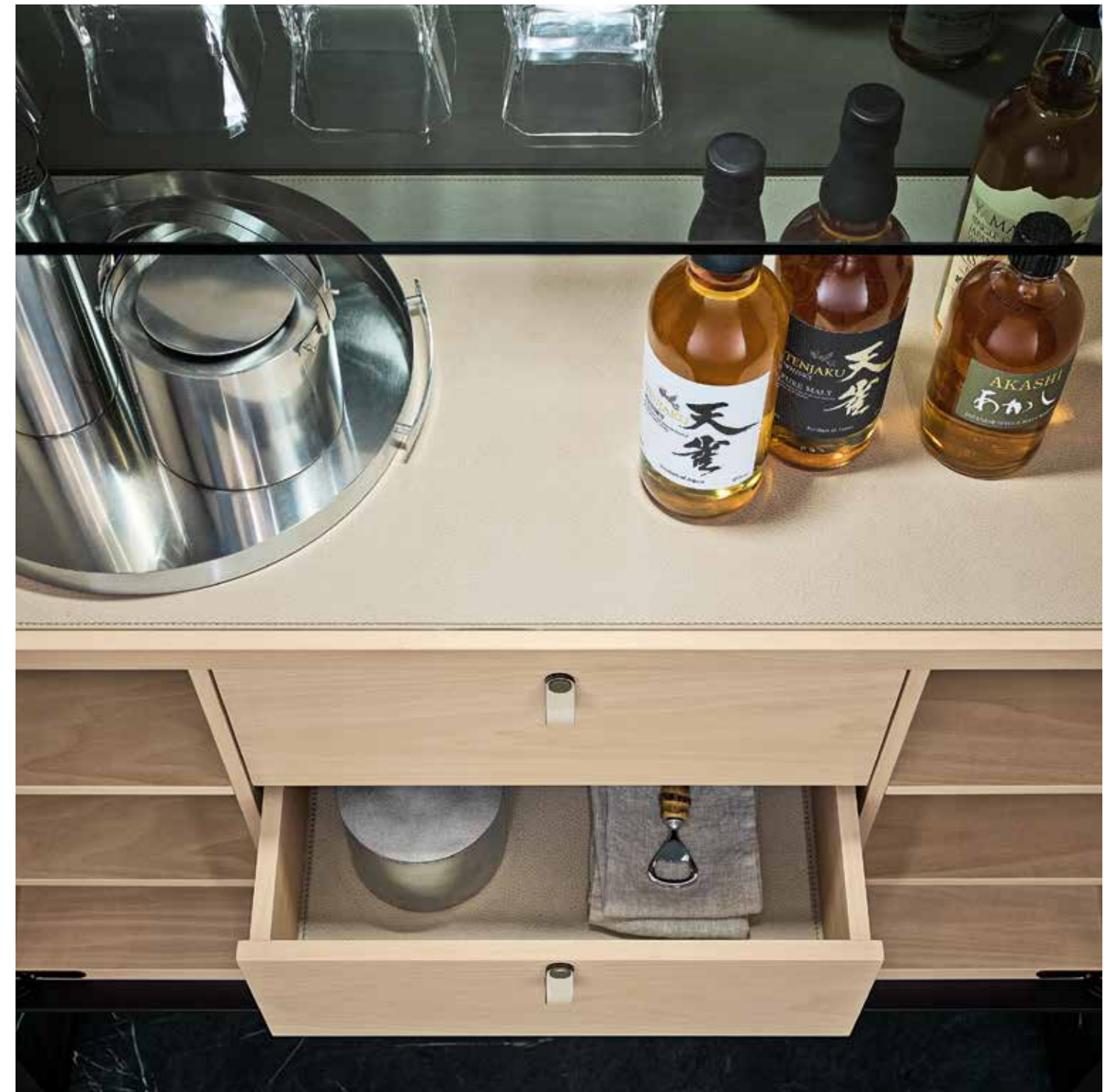
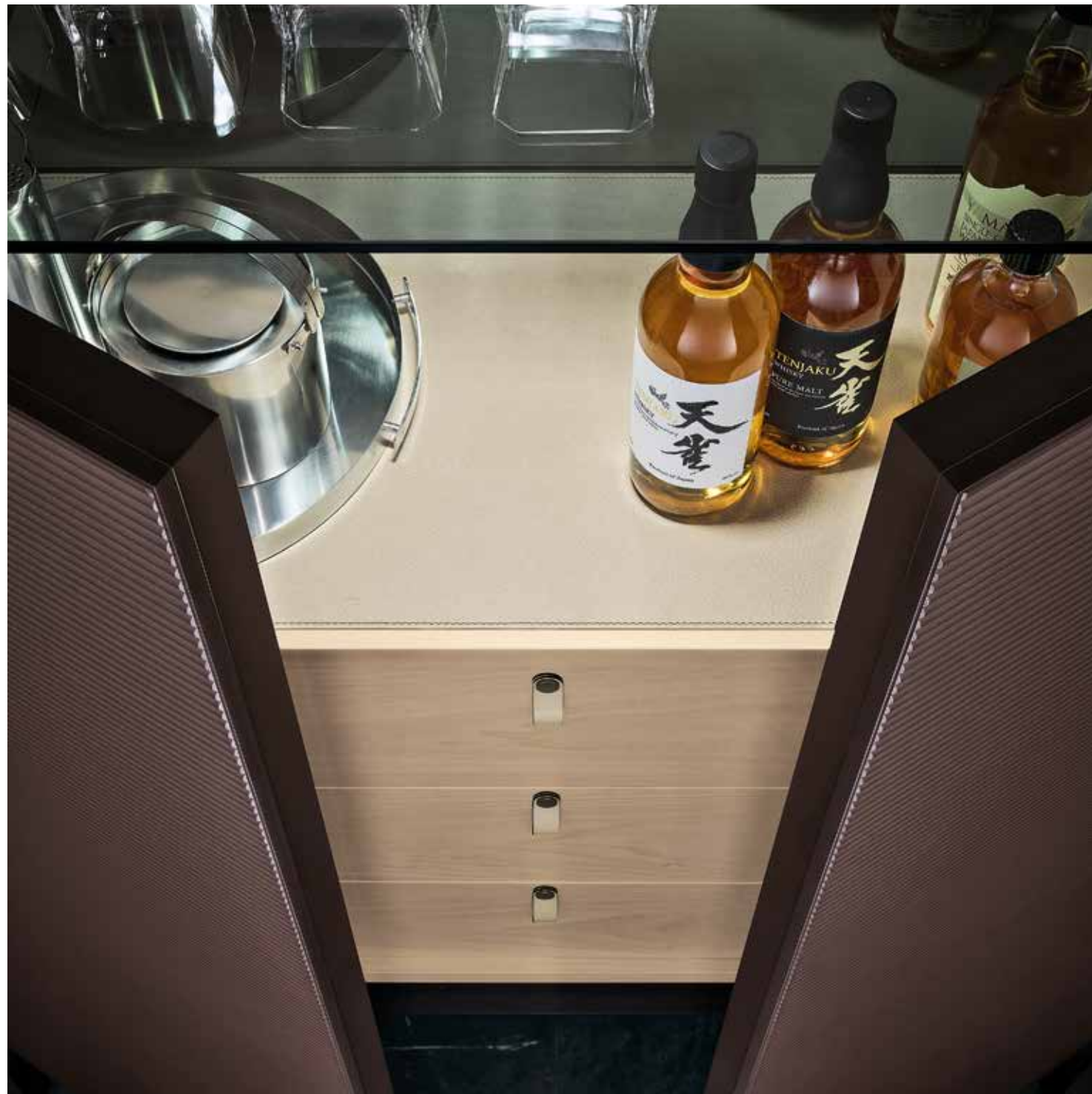

BAR CABINET
Structure: 75 amaranto
Doors: 807 amaranto taiga
Glass top: 129 amaranto opaco
Shelf: 63 grigio trasparente
Internal back panel: 68 specchio grigio
Internal in natural light wood
and synthetic leather 157 arena
H 1563 W 1073 D 470



BAR CABINET
Structure: 315 verde scuro
Glass doors: 515 verde scuro sahara
Glass top: 148 verde scuro opaco
Shelf: 63 grigio trasparente
Internal back panel: 68 specchio grigio
Internal in natural light wood
and synthetic leather 157 arena
H 1563 W 1073 D 470

Sideboard

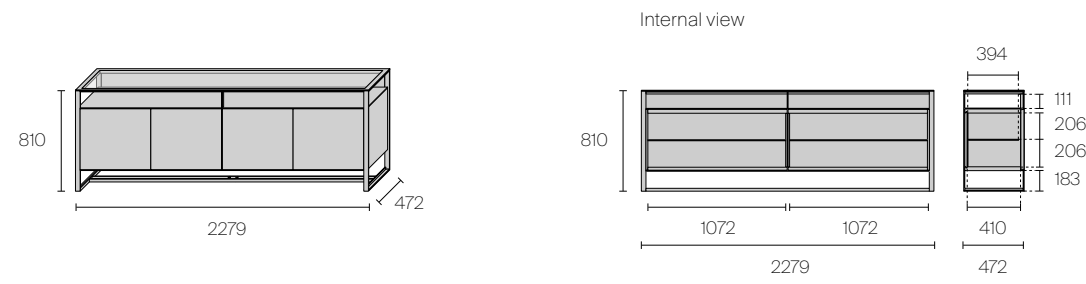

Console

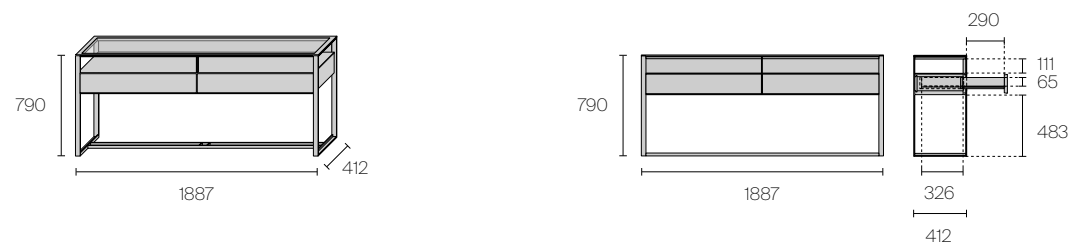

Bar cabinet

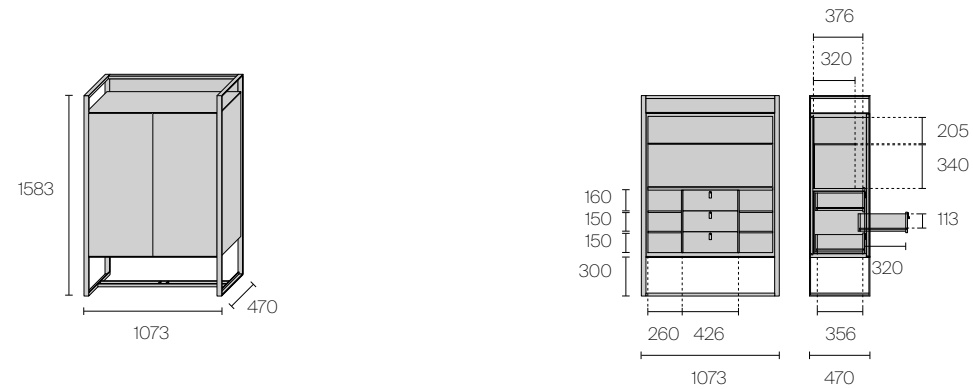

TECHNICAL DESCRIPTION

EN Rialto is a collection composed of back-finished free-standing furniture elements, characterised by external material finishings such as wood and glass in sahara and taiga and a complete range of glossy and matt lacquered glass. All the cabinets feature an indirect LED lighting system for the upper surface. The sideboard, console and the bar unit are characterised by the use of natural light wood for the interiors of the cabinets, while the sideboard and bar unit are fitted with a directional spotlight with motion sensor for internal lighting.

IT Rialto è una collezione composta da elementi d'arredo freestanding retrofiniti, caratterizzati da materiche finiture esterne come le essenze e i vetri sahara e taiga e da una gamma completa di vetri laccati lucidi e opachi. Per tutti i contenitori è previsto un sistema di illuminazione led a luce indiretta per il top superiore. La madia, la consolle e il mobile bar sono caratterizzati dall'utilizzo del legno chiaro naturale per gli interni dei contenitori, mentre la madia e il mobile bar sono dotati internamente di un faretto direzionale con sensore di presenza per l'illuminazione interna.

DE Rialto ist eine Kollektion aus aneinandergereihten, frei stehenden Möbel-Elementen mit strukturierten Oberflächen wie Sahara- und Taiga-Holz und -Glas sowie einer breiten Palette an glänzend und matt lackiertem Glas. Eine indirekte LED-Beleuchtung ist für alle Stauräume im oberen Bereich vorgesehen. Das Sideboard, die Konsole und der Barschrank zeichnen sich durch die Verwendung von natürlichem, hellem Holz für die Innenausstattung der Behälter aus, während das Sideboard und der Barschrank mit einem Richtstrahler mit Anwesenheitssensor für die Innenbeleuchtung ausgestattet sind.

FR Rialto est une collection d'éléments d'ameublement autoportants, positionnables partout dans la pièce, caractérisés par des finitions extérieures texturées telles que les essences de bois et le verre sahara et taiga, et par une gamme complète de verres laqués brillants et mats. Tous les éléments de rangement peuvent être complétés par un système d'éclairage LED indirect pour le plateau supérieur. Les éléments de rangement du bahut, de la console et du meuble de bar sont en bois clair naturel, tandis que l'intérieur du bahut et du meuble de bar est équipé d'un spot directionnel avec capteur de présence.

ES Rialto es una colección compuesta por elementos de decoración autoportantes con un aire retro, caracterizados por sus acabados exteriores en materiales como madera sahara y taiga, vidrio y una gama completa de vidrio lacado brillante y mate. Todos los contenedores de la parte superior disponen de un sistema de iluminación LED indirecta. El aparador, la consola y el mueble bar se caracterizan por el uso de madera clara natural para los interiores de los contenedores, mientras que el aparador y el mueble bar están equipados, en su interior, con un foco direccional con sensor de presencia para la iluminación interior.

RU Rialto — это коллекция, состоящая из отдельно стоящих элементов мебели, имеющих декоративно облицованную заднюю стенку, с фактурной внешней отделкой, такой как дерево и стекло sahara и taiga, а также полным спектром глянцевого и матового лакированного стекла. Для верхней части всех отделений для хранения предусмотрена непрямая светодиодная подсветка. Тумба, консоль и барный шкаф отличаются использованием натурального светлого дерева внутренней части отделений для хранения, в то же время тумба и барный шкаф оснащены направленным точечным светильником с датчиком присутствия для внутреннего освещения.

汉语 Rialto 为一款背饰独立家具，意为可自由在空间内摆放而不需依靠墙面的设计；设计特色为木材、各式 Sahara 和 Taiga 玻璃以及广泛多样的亮面漆和哑光漆玻璃等外部材质。餐边柜、长桌和酒吧柜的特色为采用天然浅色木材打造内部收纳空间。餐边柜和酒吧柜的内部照明为配有动作传感器的定向聚光灯。

TECHNICAL DETAILS



1



2



3



4

1. Led lighting 3000° Kelvin (warm light) with touch system for switch on/off and light intensity adjustment.
2. Multiple socket integrated on bar unit internal top, with two electrical sockets available in different configurations. Closing flap matching the bar unit structure.
3. Adjustable spotlight with two lights with sensor.
4. Battery spotlight with motion sensor, colour of temperature 3000° Kelvin (warm light), Lithium Ion battery 3.7V, 2600 mAh, rechargeable by induction or micro USB cable.
5. Wall plug.

Sideboard with full led lighting

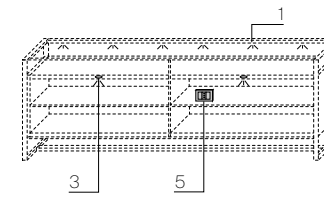

Bar cabinet with full led lighting

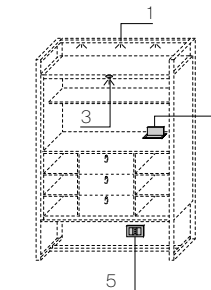

Battery led spotlight

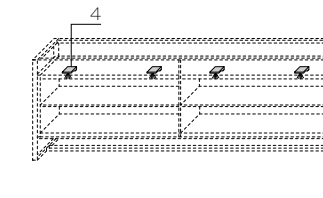

Battery led spotlight

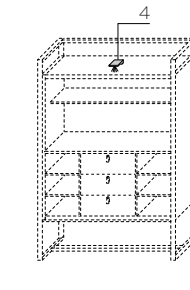

Console with full led lighting

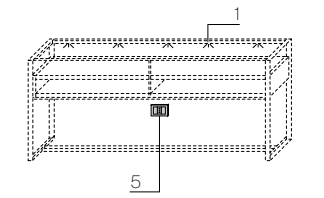

Structure, side panel, back panel and base

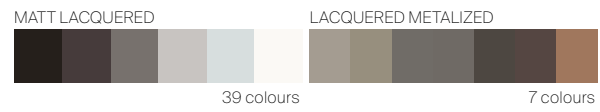

Door

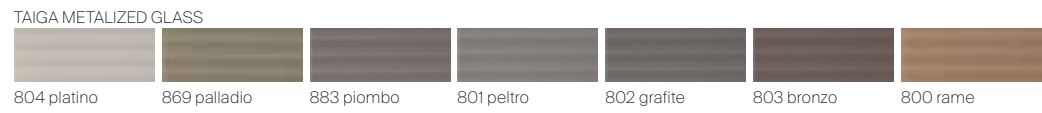
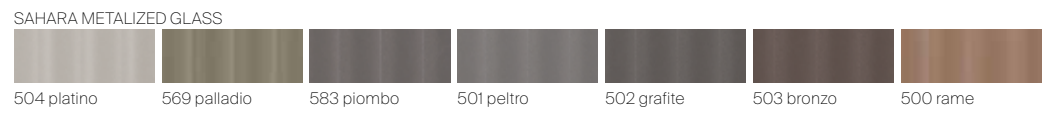
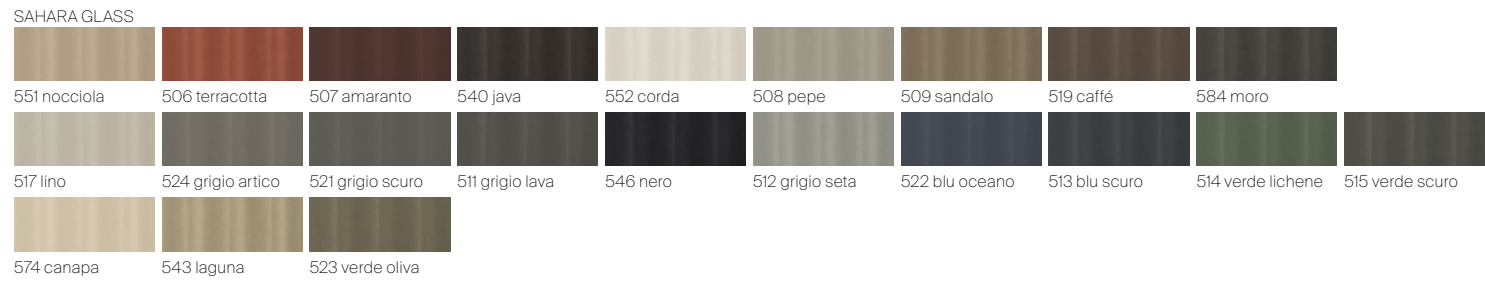

Bar unit top, sideboard and console lower top



Sideboard and console top

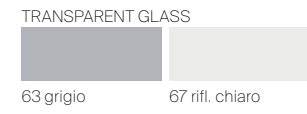

Console drawer front

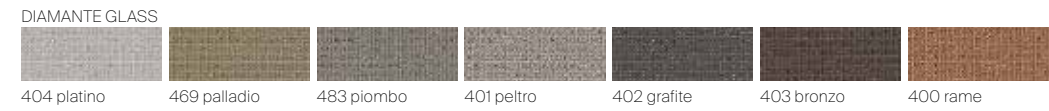
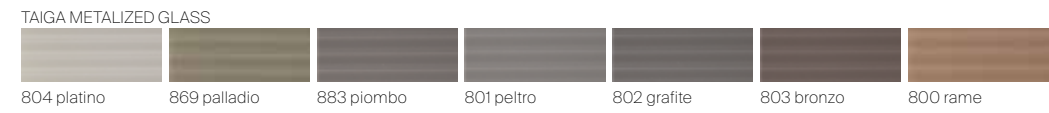
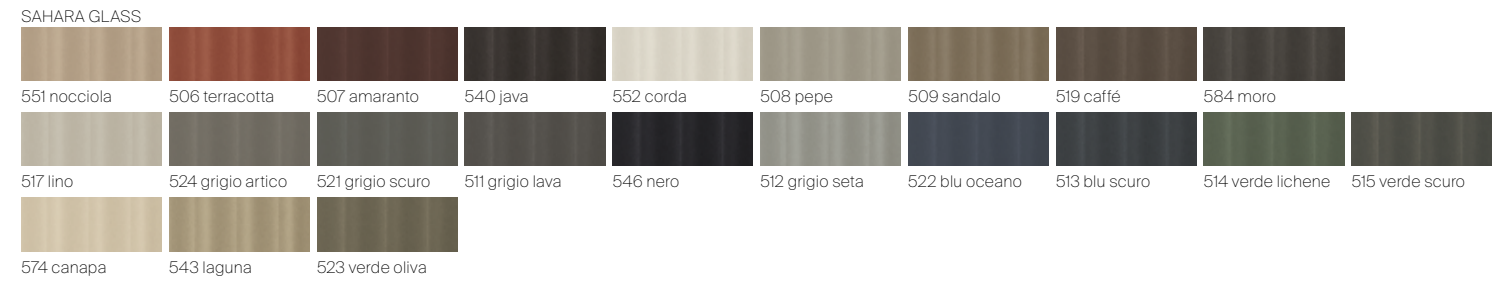
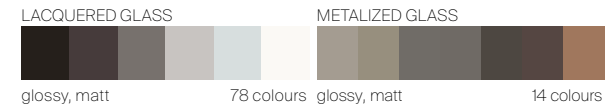

Internal finishing of drawer, bar unit internal top and bar unit drawer handle



Internal shelf



Internal back panel for bar unit





WITH ALAMBRA, RIMADESIO GIVES A CONTEMPORARY REINTERPRETATION OF CLASSIC FURNITURE LIKE SIDEBOARDS, GLASS CABINETS AND DRAWER UNITS. A COLLECTION CHARACTERIZED BY THE PARTICULAR STRUCTURE IN ALUMINIUM, BY EXCLUSIVE DESIGN DETAILS, BY THE MECHANISMS OF MOVEMENT AND BY SHELVES EQUIPPED WITH INTEGRATED LED LIGHTING SYSTEM. A PROPOSAL AVAILABLE IN VARIOUS SIZES AND WITH DIFFERENT TECHNICAL INTERNAL EQUIPMENT.

IT Con Alambra, Rimadesio propone una reinterpretazione in chiave contemporanea di tipologie classiche dell'arredo come madie, vetrine e cassettiere. Una collezione caratterizzata dalla particolare struttura in alluminio, dal disegno esclusivo dei dettagli, dai meccanismi di movimento e dotata di illuminazione a led integrata nei ripiani. Una proposta articolata in varie dimensioni e dotata di attrezzature tecniche differenziate.

DE Mit Alambra bietet Rimadesio eine gemäßige Neuinterpretation den klassischen Möbeltypen wie Sideboard, Vitrine und Schubladen Elementen an. Eine Kollektion von der besonderer Struktur aus Aluminium charakterisiert, exklusive Design-Details, Mechanismen der Bewegung und Led-Beleuchtung integriert bei Fachböden. Einer artikulierter Vorschlag in verschiedenen Massen und mit differenzierten technischen Ausrüstungen.

FR Avec Alambra, Rimadesio propose une réinterprétation contemporaine de meubles comme les bahuts, les vitrines et les blocs tiroirs. Une collection caractérisée par une particulière structure en aluminium, par des détails exclusifs de design, par mécanismes de mouvement et équipée de système d'éclairage à led intégré dans les étagères. Une proposition disponible en différentes dimensions et avec équipements différents.

ES Con Alambra, Rimadesio ofrece una reinterpretación contemporánea de tipologías clásicas de mobiliario como aparadores, vitrinas y cajoneras. Una colección que se caracteriza por la estructura particular en aluminio, de diseño exclusivo de los detalles, de los mecanismos de movimiento y dotada de iluminación por leds integrada en los estantes. Una propuesta que se articula en varios tamaños y con interiores diferentes.

RU Компания Rimadesio предлагает современное переосмысление классических типов мебели — шкафов, витрин и тумб — новой коллекции Alambra. Коллекция отличается особой алюминиевой конструкцией, эксклюзивным дизайном деталей, механизмами Открывания и светодиодной подсветкой, встроенной в полки. Коллекция представлена в различных размерах и с Различным внутренним оснащением.

汉语 Rimadesio 通过 Alambra 掌握橱柜、展示柜和抽屉柜等经典家具的现代调性并重新诠释。系列特色为特殊的铝合金架构、独特的设计细节与多样的移动装置·LED 照明装置嵌入于层板之中。该产品系列提供多种尺寸并附有不同的技术配件。



Structure: 13 nero
Glass: 63 grigio trasparente
Internal: 19 rovere termotrattato
W 2616 H 1516 D 500

In this photo
Wall panelling system: Modulor

EN Available with or without crosspieces, entirely made in extruded aluminium, the project of the Alambra door is focusing the attention on details, typical of all the Rimadesio proposals. The precision of the opening movement, the innovation introduced by the closing system with neodymium magnets, the absence of visible screws, joints and plastic gaskets are the results of an exclusive technical research.

IT Disponibile con o senza traversini, interamente realizzata in alluminio estruso, l'anta di Alambra è un progetto in cui si concentra l'attenzione al dettaglio tipica della proposta Rimadesio. La precisione del movimento di apertura, l'innovazione introdotta dal sistema di chiusura con magneti al neodimio, la totale assenza di viti, giunzioni e guarnizioni in plastica sono il risultato di una ricerca tecnica esclusiva.

DE Die Tuer von Alambra aus extrudiertem Aluminium ist mit oder ohne Sprossen erhaeltlich. Rimadesio konzentriert sich auch auf Details. Die Genauigkeit der Oeffnung der Tuer, die Innovation der Schliessung mit Magneten in Neodym, keine Sichtschrauben und Verbindungsteile aus Kunststoff sind das Ergebnis der exklusiven technischen Forschung die her bei Firma Rimadesio gemacht wurde.

FR La porte de Alambra, disponible avec ou sans traverses, entièrement en aluminium extrudé, est un projet dédié à l'attention du détail, caractéristique commune à toutes les propositions Rimadesio. La précision du mouvement d'ouverture, la nouveauté introduite par le système de fermeture avec des aimants de néodyme, l'absence totale de vis et joints en plastique, même à son intérieur, sont également le résultat d'une recherche technique très exclusive.

ES Disponible con o sin travesaños, hecha enteramente en aluminio extruido, la puerta de Alambra es un proyecto en que se centra la atención al detalle típica de la propuesta Rimadesio. La precisión del movimiento de apertura, la innovación introducida por el sistema de cierre con imanes de neodimio, la total ausencia de tornillos, juntas y gomas también en el interior son el resultado de una búsqueda técnica exclusiva.

RU Дверь Alambra, изготовленная полностью из экструдированного алюминия, доступна с поперечными перемычками или без них, — это дизайн, в котором максимально сконцентрировано внимание к деталям, характерное для Rimadesio. Точность механизма открывания, инновационная система запираения с неодимовыми магнитами, полное отсутствие винтов, соединений и пластиковых уплотнителей — все это результат эксклюзивных технических исследований.

汉语 Alambra 的门扇以全挤出铝合金制成，带横挡或不带横挡皆可，在这其中 Rimadesio 倾注了对设计细节一贯的重视。开启门扇的精确运动搭配新引进的钕磁铁闭合系统，完全舍弃螺钉、连接件和塑料垫圈，上述皆为独家技术的研究成果。





BAR UNIT
Structure: 304 platino
Doors, sides and shelf: 63 grigio trasparente
Back panel: 68 specchio grigio
Top: 137 platino opaco
W 1308 H 1659 D 500

EN The Alambra bar is a unit with built-in refrigerator, fitted with open compartments and doors in noce, rovere termotrattato and rovere nero. The tops, handles and trays are available in synthetic leather in the 8 colours from the Rimadesio sample collection. An integrated LED lighting system is also provided.

IT La versione Alambra bar è un mobile con frigorifero interno, dotato di vani a giorno ed anta in legno noce, rovere termotrattato e rovere nero. I top, le maniglie e i vassoi sono disponibili in similpelle negli 8 colori a campionario Rimadesio. È previsto inoltre un sistema illuminazione a led integrato.

DE Die Barversion von Alambra ist ein Schrank mit einem Kühlschrank im Inneren, der mit offenen Fächern und Türen aus Noce, Rovere Termotrattato und Rovere Nero ausgestattet ist. Die Oberteile, Griffe und Tablets sind aus Kunstleder in den 8 Rimadesio-Musterfarben erhältlich. Ein integriertes LED-Beleuchtungssystem ist ebenfalls vorgesehen.

FR La version Alambra bar est un meuble avec réfrigérateur intégré, équipé de compartiments ouverts et d'une porte en noce, rovere termotrattato et rovere nero. Les plateaux, poignées et tablettes sont disponibles en similcuir dans les 8 couleurs du muestrario Rimadesio. Un système d'éclairage LED intégré est également prévu.

ES La versión bar Alambra es un mueble con frigorífico interno, equipado con compartimentos abiertos y puertas de madera noce, rovere termotrattato y rovere nero. Los tops, los tiradores y las bandejas están disponibles en simil cuero, en los ocho colores del muestrario de Rimadesio. También se proporciona un sistema de iluminación LED integrado.

RU Барная версия Alambra — это шкаф со встроенным холодильником, оснащенный открытыми отделениями и дверцей из орехового дерева, термообработанного Или черного дуба. Столешницы, ручки и Лотки предлагаются с отделкой из искусственной кожи в 8 цветовых вариантах Rimadesio. Также предусмотрена встроенная система светодиодного освещения.

汉语 Alambra 版本的酒吧柜内设有冰箱、开放式收纳空间搭配以胡桃木、热处理橡木和黑橡木打造的门扇。台面、把手和托盘以仿真皮革包覆，在 Rimadesio 的样品集中共有 8 种颜色可供选择。除此之外，亦可配置集成 LED 照明系统。

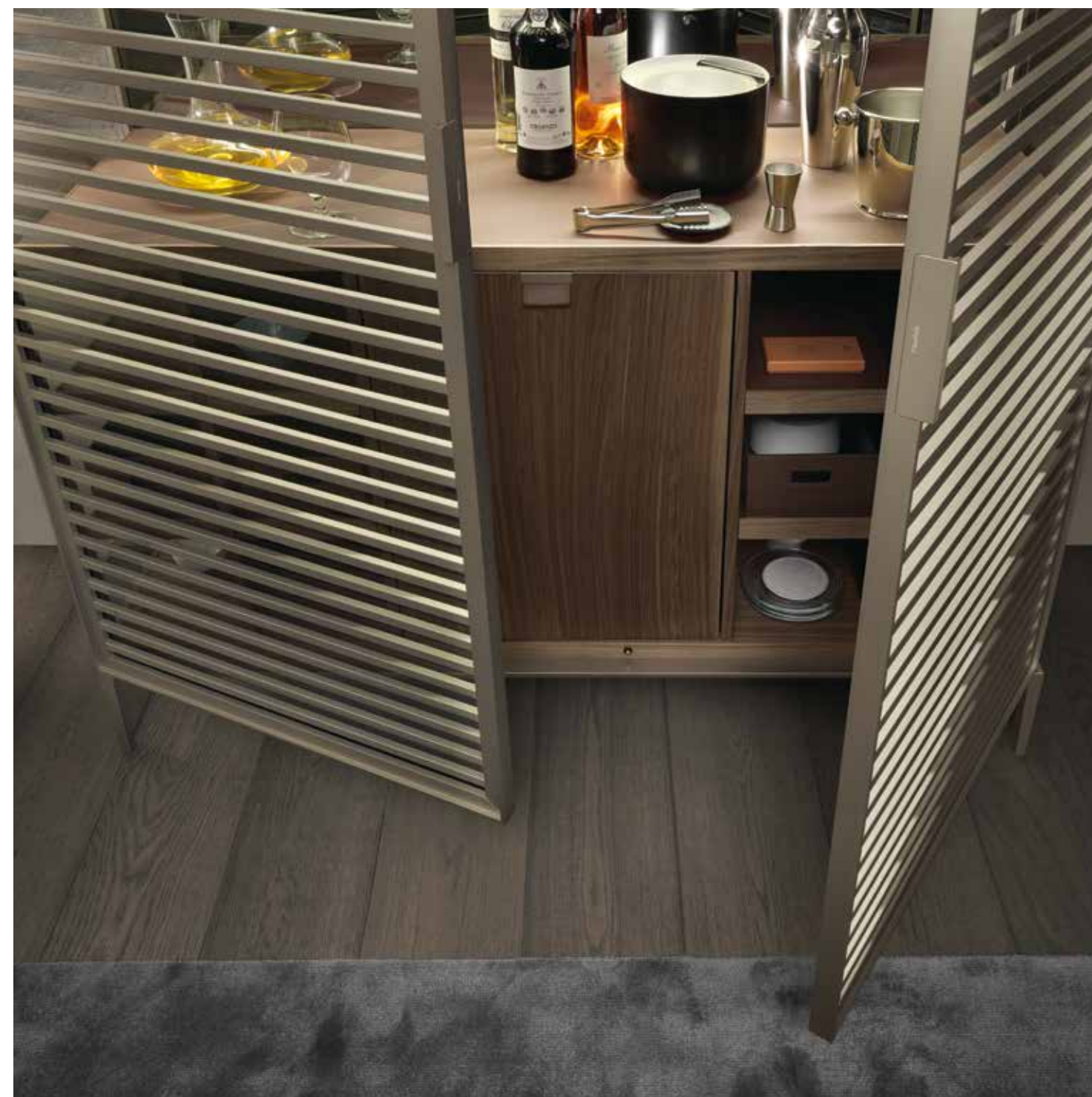

BAR UNIT
Structure: 304 platino
Doors, sides and shelf: 63 grigio trasparente
Back panel: 68 specchio grigio
Top: 137 platino opaco
W 1308 H 1659 D 500





Structure: 13 nero
Doors: 03 acidato grigio
Top: 102 nero opaco
Side and back panels: 64 riflettente grigio
W 2616 H 833 D 500



Structure: 14 brown
Glass: 03 acidato grigio
Top: 99 caffè opaco
Drawers: 19 rovere termotrattato
Internal shelf: 63 trasparente grigio
W 2616 H 833 D 500

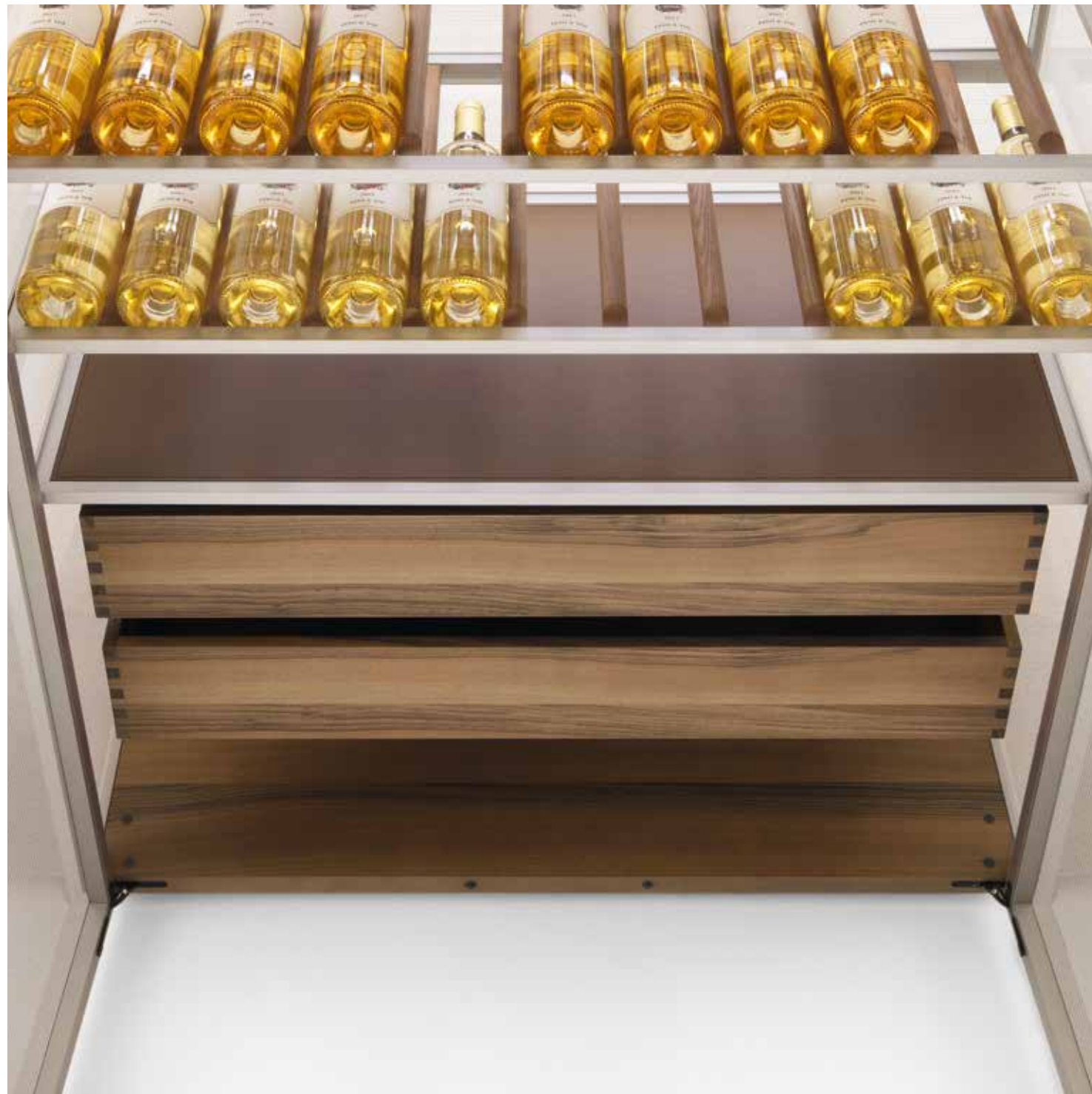



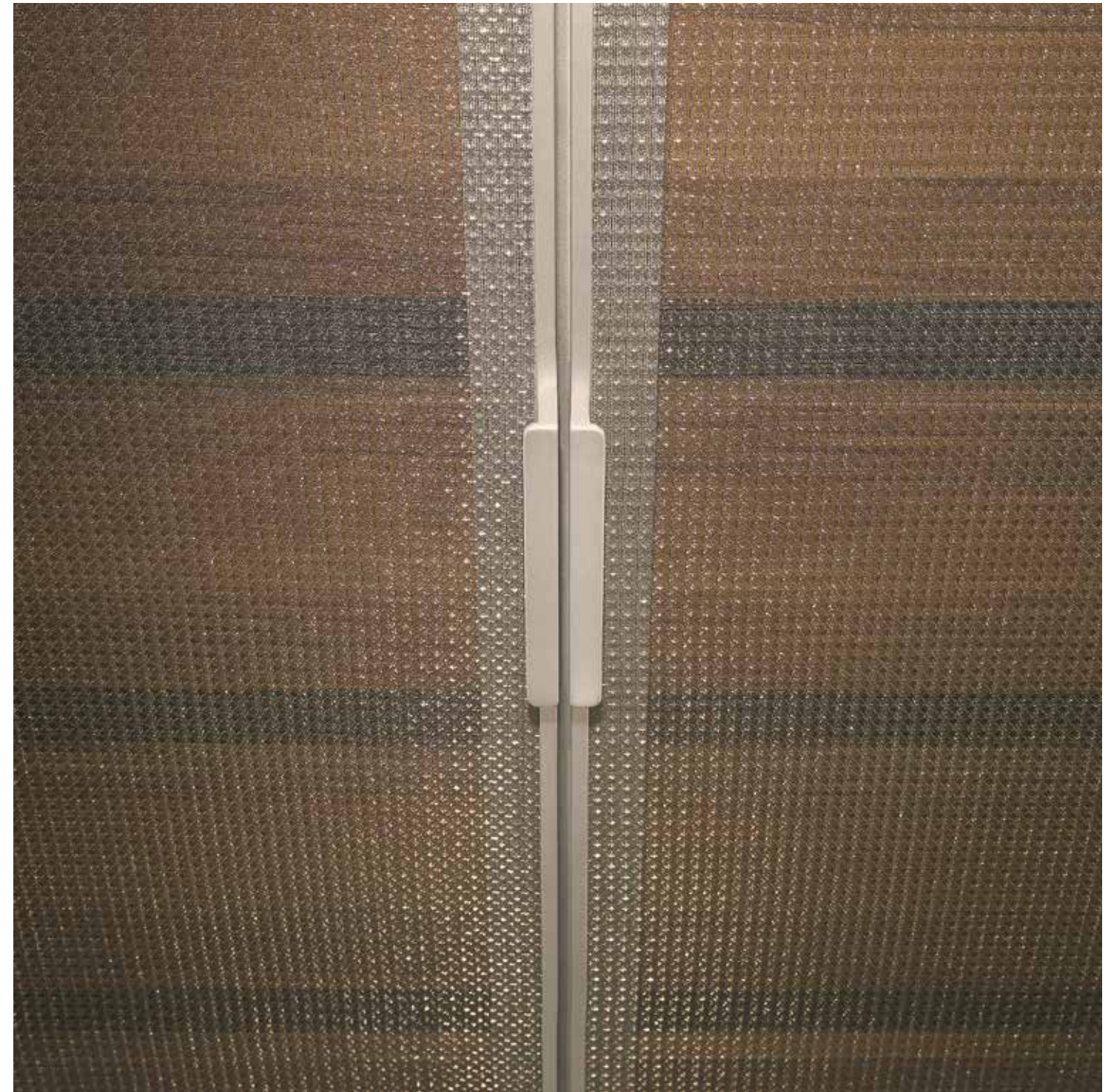



Structure: 13 nero
Glass: 63 grigio trasparente
Drawers: 27 rovere nero
Back panel: 73 giallo kashmir lucido
Drawer internal lining: 153 castoro
W 1308 H 1659 D 500



SIDEBOARD WITH TRANSPARENT TOP
AND INTERNAL DRAWERS
Structure: 304 platino
Glass: 63 grigio trasparente
Drawers and base: 15 noce
Drawer internal lining: 153 castoro
W 2016 H 833 D 500



SIDEBOARD WITH TRANSPARENT TOP
AND INTERNAL SHELF
Structure: 304 platino
Glass: 64 riflettente grigio
Base: 15 noce
Internal shelf: 63 grigio trasparente
W 2016 H 833 D 500



ALAMBRA ISOLA
MIDDLE ROOM DISPLAY UNIT
Structure and base: 303 bronzo
Glass: 67 riflettente chiaro
Drawers: 15 noce
Drawer internal lining: 153 castoro
Internal back: 68 specchio grigio
Glass shelves: 63 grigio trasparente
W 2016 H 833 D 939



ALAMBRA ISOLA
MIDDLE ROOM DISPLAY UNIT
Structure and base: 303 bronzo
Glass: 67 riflettente chiaro
Drawers: 15 noce
Drawer internal lining: 153 castoro
Internal back: 68 specchio grigio
Glass shelves: 63 grigio trasparente
W 2016 H 833 D 939

EN Alambra Isola is a free-standing display cabinet specifically designed for bedrooms and retail spaces. The top is available in transparent satin, diamante and glossy or matt lacquered glass; the fittings are in noce wood and synthetic leather. The internal back panel is in grey mirror glass.

IT Alambra isola è un mobile espositore centrostanza appositamente studiato per la zona notte e per gli spazi retail. Il top è disponibile in vetro trasparente satinato, diamante e laccato lucido o opaco; le attrezzature sono in essenza noce e similpelle. Lo schienale interno è in specchio grigio.

DE Alambra isola ist ein speziell für das Schlafzimmer und den Verkaufsraum konzipiertes Möbelstück. Die Oberfläche ist aus transparentem, satiniertem, diamante und glänzend oder matt lackiertem Glas erhältlich; die Beschläge sind aus Noce und Kunstleder. Die Rückwand im Inneren ist aus einem grauen Spiegel gestaltet.

FR Alambra isola est une vitrine autoportante spécialement conçue pour l'espace nuit et les espaces commerciaux. Le plateau est disponible en verre transparent satiné, diamante et laqué brillant ou mat; les équipements sont en bois noce et similicuir. Le fond intérieur est gris réfléchissant.

ES Alambra isla es un mueble expositor independiente diseñado específicamente para dormitorios y espacios comerciales. El top está disponible en cristal transparente satinado, diamante y lacado brillante o mate; el equipamiento está fabricado en madera noce y símil cuero. La parte trasera interior es de espejo gris.

RU Остров из коллекции Alambra — это центральная витрина, специально разработанная для спальни и торговых залов. Столешница доступна в прозрачном сатинированном, бриллиантовом, глянцевоом или матовом лакированном стекле; фурнитура — из орехового дерева и кожзаменителя. Внутренняя часть стеновой панели выполнена из серого зеркала.

汉语 Alambra Isola 是一款独立的展示柜，专为卧室和零售空间所设计。台面可采用透明缎面、Diamante、亮面漆和哑光漆等玻璃表面处理；配件材质有胡桃木和仿真皮革可供选择。内部背板为灰色镜面。



ALAMBRA ISOLA
MIDDLE ROOM DISPLAY UNIT
Structure and base: 303 bronzo
Glass: 67 riflettente chiaro
Drawers: 15 noce
Drawer internal lining: 153 castoro
Internal back: 68 specchio grigio
Glass shelves: 63 grigio trasparente
W 2016 H 833 D 939



SUSPENDED CABINET WITH FLAP DOOR
Structure: 13 nero
Glass door and sides: 490 trasparente diamante
Back panel: 68 specchio grigio
Internal top: 102 nero opaco
W 1603 H 386 D 316

In this photo
Shelf: Eos
Suspended cabinet: Self plan
Coffee table: Tray
Sliding door: Stripe



SUSPENDED CABINET WITH FLAP DOOR
Structure: 13 nero
Glass door and sides: 490 trasparente diamante
Back panel: 68 specchio grigio
Internal top: 102 nero opaco
W 1603 H 386 D 316



SUSPENDED CABINET WITH FLAP DOOR
Structure: 303 bronzo
Door, sides and top: 67 riflettente chiaro
Internal top: 303 bronzo lucido
Back panel: 68 specchio grigio
W 1538 H 386 D 316

EN The suspended cabinet is equipped with an exclusive invisible mechanism for the opening of the flap door, specifically designed for this refined wall version, the result of Rimadesio's technological research. The led lighting system of latest generation is embedded in the horizontal aluminum profiles.

IT La vetrina pensile è dotata di un esclusivo meccanismo invisibile per l'apertura dell'anta ribalta, specificatamente progettato per questa raffinata versione a parete, frutto della ricerca tecnologica Rimadesio. L'illuminazione led di ultima generazione è incassata nei profili orizzontali in alluminio.

DE Die Hängevitrine ist mit einem exklusiven unsichtbaren Mechanismus für das Öffnen der Klapptür ausgestattet. Letzterer ist das Ergebnis der technologischen Forschung Rimadesios, das speziell für diese raffinierte Wandversion ausgelegt ist. Die Led-Beleuchtung der neuesten Generation ist in die horizontalen Aluminiumprofile eingebettet.

FR La vitrine suspendue est équipée d'un exclusif mécanisme invisible pour l'ouverture de la porte abattante, spécialement conçu pour cette version murale raffinée, comme résultat de la recherche technologique Rimadesio. L'éclairage led de dernière génération est intégré dans les profilés horizontaux en aluminium.

ES La vitrina colgante está equipada de un exclusivo mecanismo invisible para la apertura de la puerta abatible, específicamente diseñado para esta versión refinada a pared, resultado de la investigación tecnológica de Rimadesio. La iluminación led de última generación está integrada en los perfiles horizontales en aluminio.

RU Настенная витрина оснащена эксклюзивным невидимым механизмом открывания откидной дверцы, специально разработанным для этой изысканной версии, являющейся результатом технологических исследований Rimadesio. Современное светодиодное освещение встроено в горизонтальные алюминиевые профили.

汉语 壁挂式玻璃展示柜配备独家的隐形翻门开启装置，该装置是Rimadesio 的技术研究成果，专为这款精致的壁挂款式而设计。最新一代的LED照明装置嵌入呈水平的铝合金轮廓中。

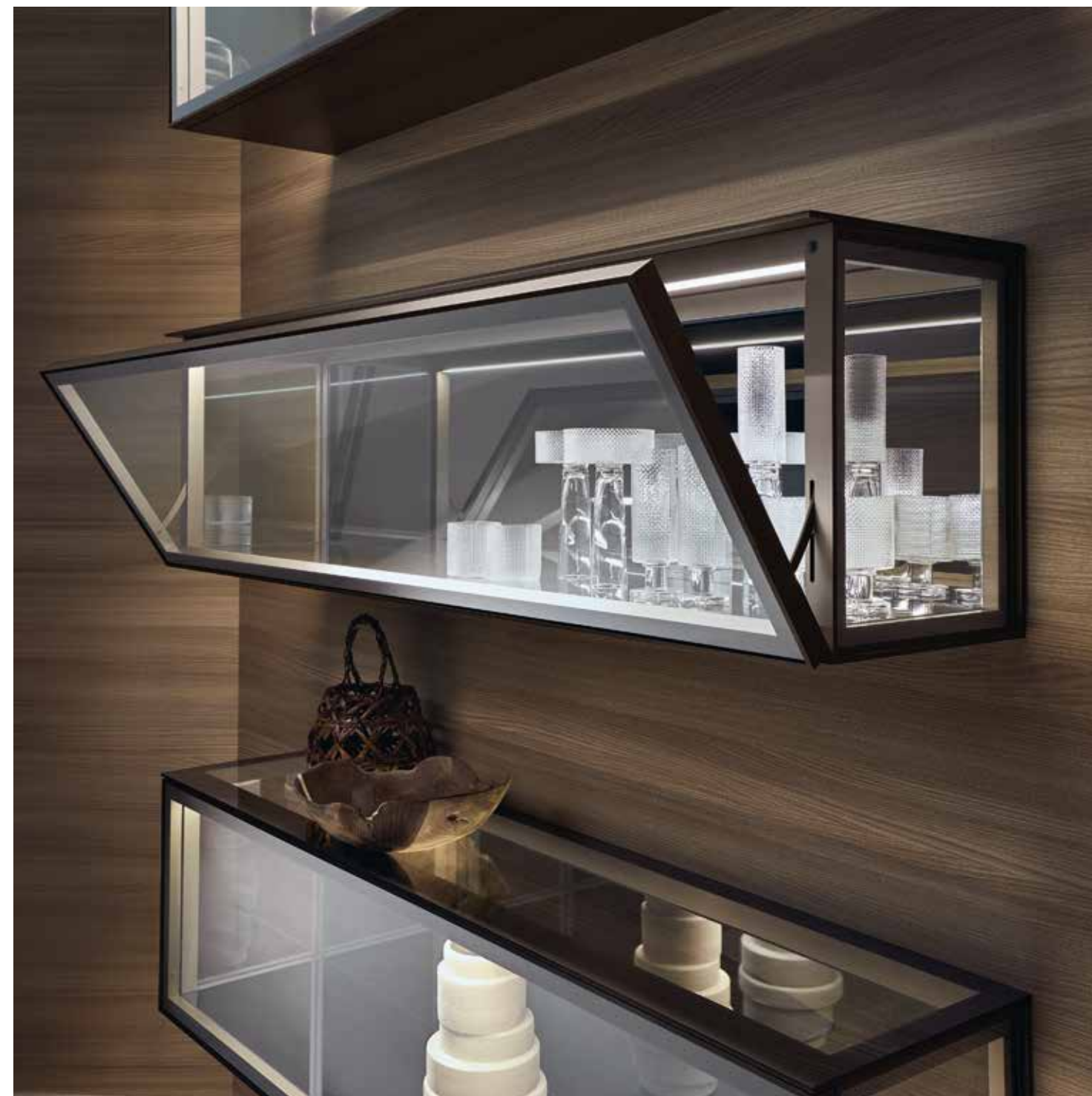

SUSPENDED CABINET WITH FLAP DOOR
Structure: 303 bronzo
Door, sides and top: 67 riflettente chiaro
Internal top: 303 bronzo lucido
Back panel: 6B specchio grigio
W 1538 H 386 D 316



SUSPENDED CABINET WITH FLAP DOOR
 Structure: 304 platino
 Door, sides and top: 67 riflettente chiaro
 Internal top: 137 platino opaco
 Back panel: 68 specchio grigio
 W 1603 H 386 D 316

In this photo
 Wall panelling system: Modulor
 Coffee table: Tray



SUSPENDED CABINET WITH HINGED DOOR
Structure: 303 bronzo
Door and side panels glass: 67 riflettente chiaro
Back panel: 68 specchio grigio
Shelves: 63 grigio trasparente
Internal drawer: 15 noce
Synthetic leather for top and drawer lining: 153 castoro
W 424 H 1604 D 338

In this photo
Wall panelling system: Modulor
Table: Manta



SUSPENDED CABINET WITH HINGED DOOR
Structure: 303 bronzo
Door and side panels glass: 67 riflettente chiaro
Back panel: 68 specchio grigio
Shelves: 63 grigio trasparente
Internal drawer: 15 noce
Synthetic leather for top and drawer lining: 153 castoro
W 424 H 1604 D 338

Version with floor base

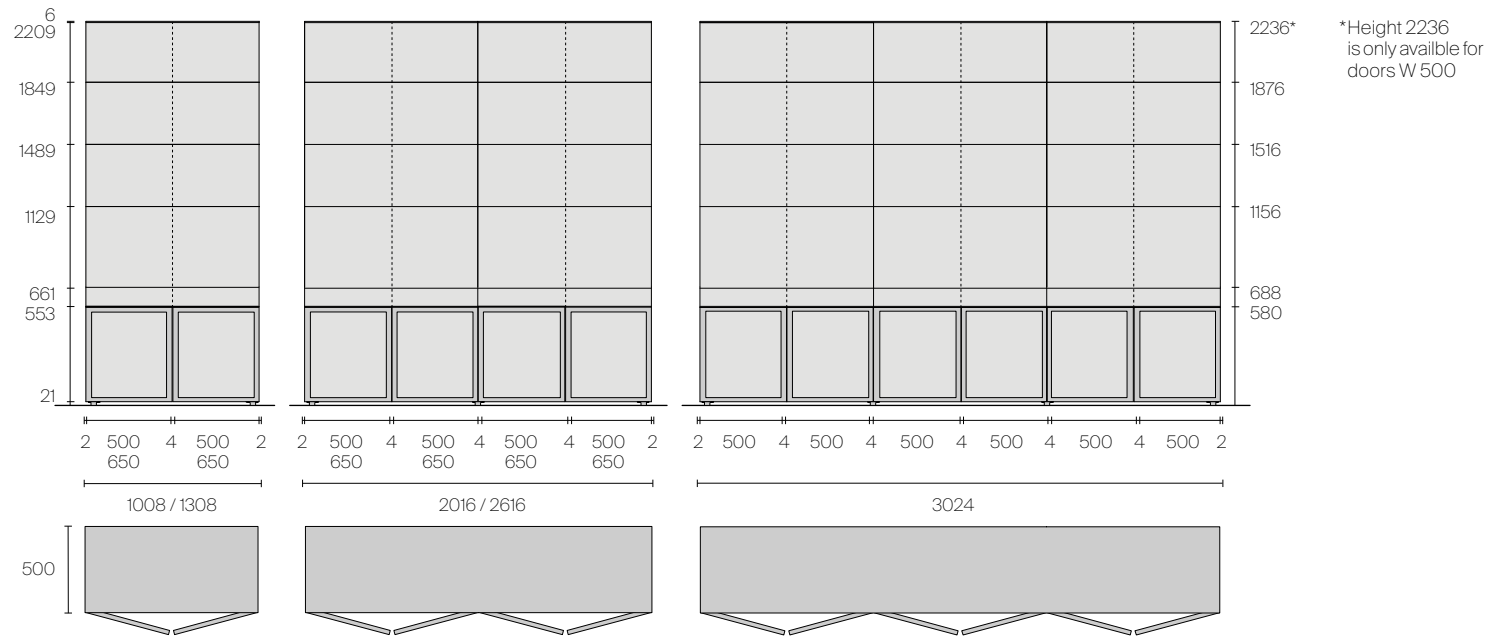

Version with legs

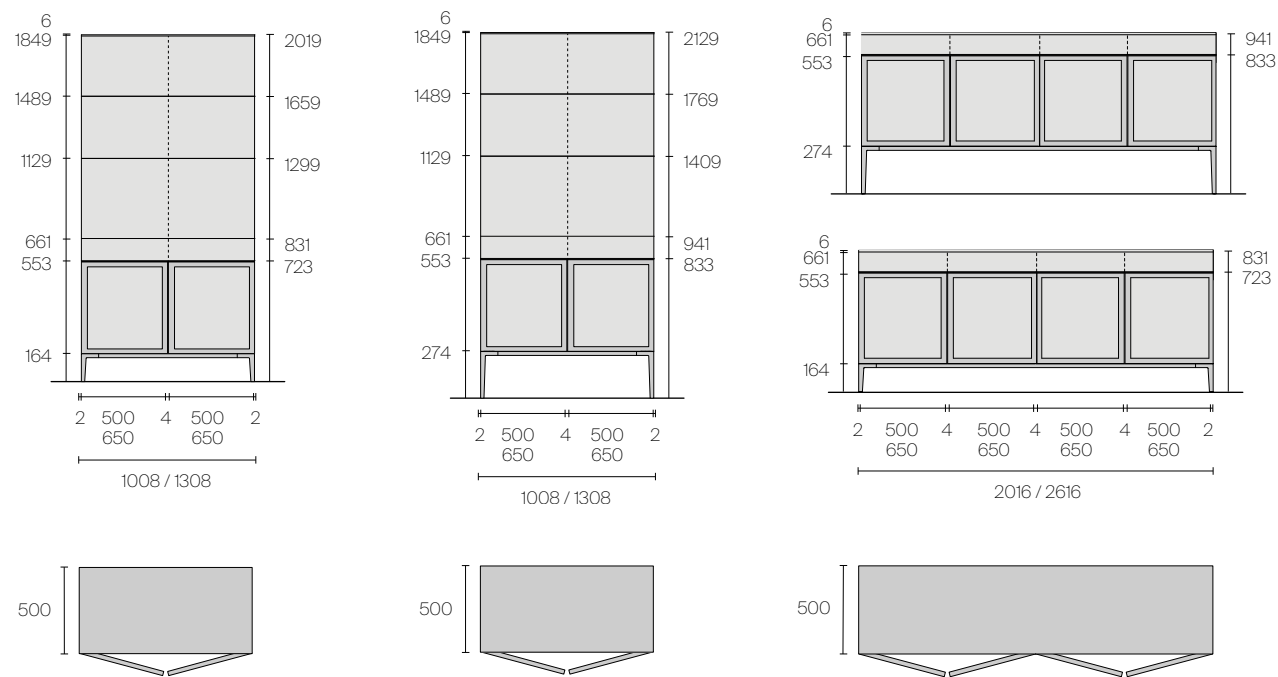

Side panel in tempered glass with aluminum frame

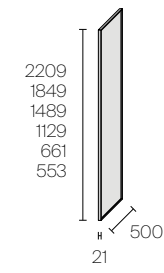

Glass back panel

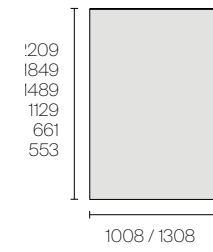

Central upright in extruded aluminum

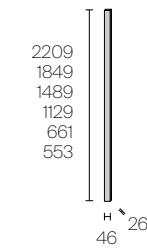

Glass door with or without crosspieces

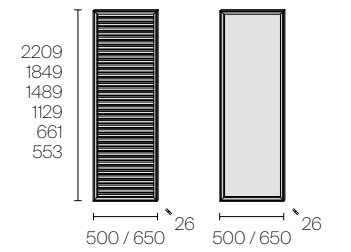

Wooden floor base

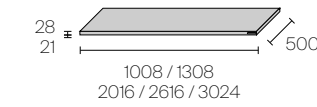

Base with legs H 164 or H 274

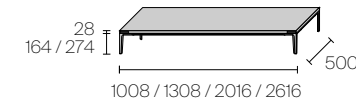

Wooden and mat lacquered glass top

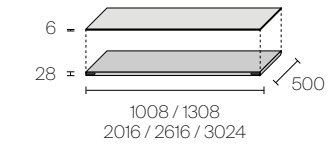

Glass top

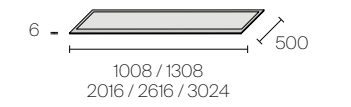

Wooden drawer unit on base

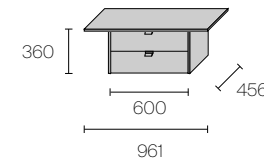

Suspended wooden drawer units

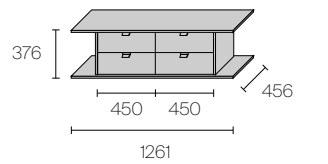
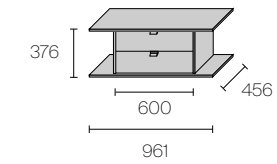
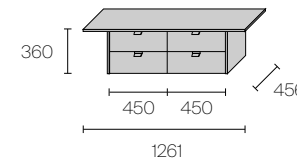

Suspended drawer

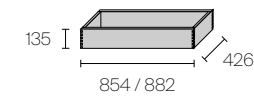

Wooden undertop drawer

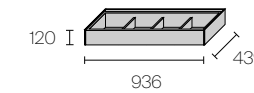
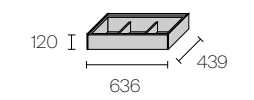

Internal glass shelf

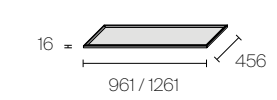

Bottle rack

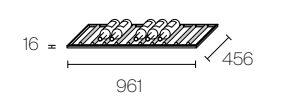

Led lighting for wooden top, glass shelf, suspended unit and bottle rack

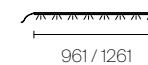

Front and back led lighting for glass top

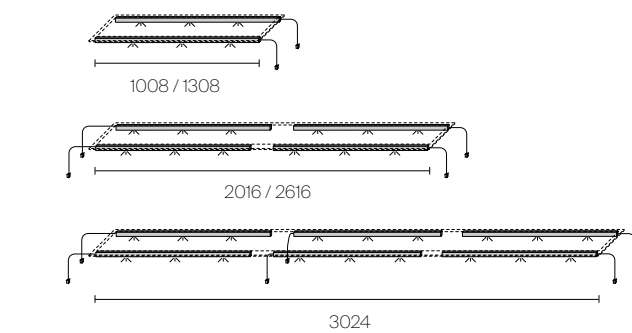

Fridge bar unit

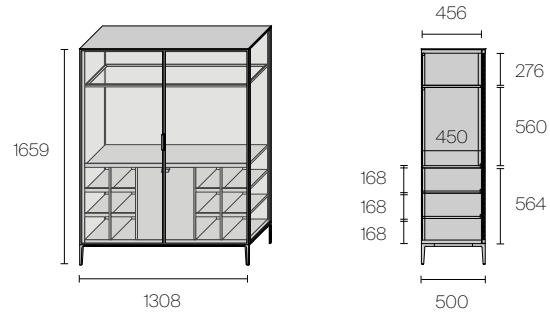

Monetiere

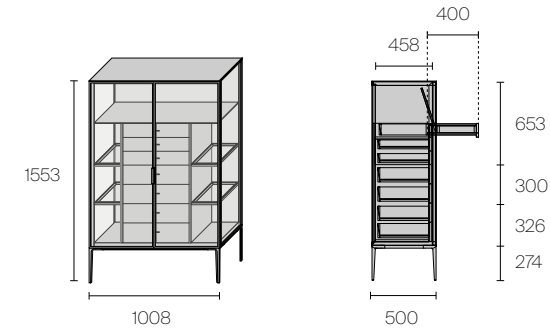

Isola: middle room display unit with glass top

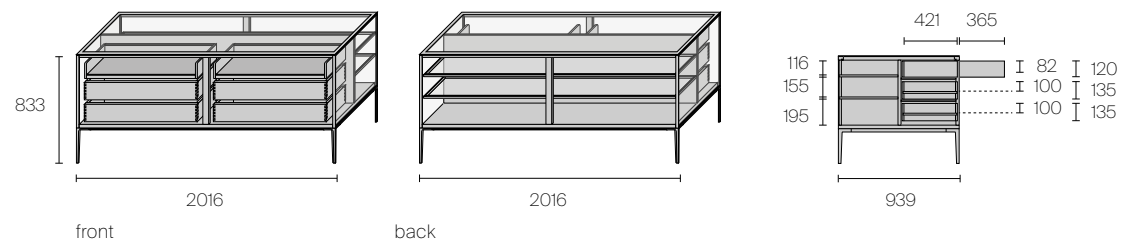

Case sideboard with suspended tray and drawers

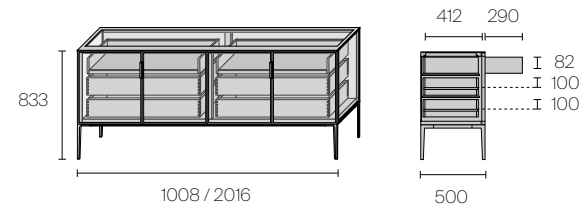

Case sideboard with suspended shelf and drawers

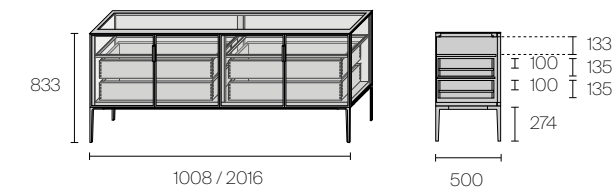

Case sideboard with drawer unit on base

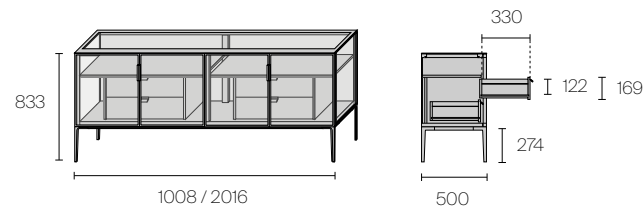

Case sideboard with shelf

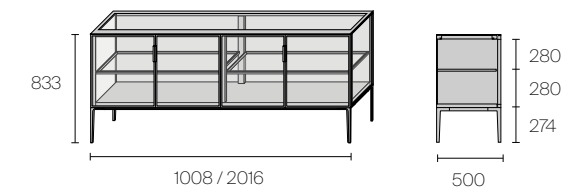

Suspended glass cabinet with hinged door

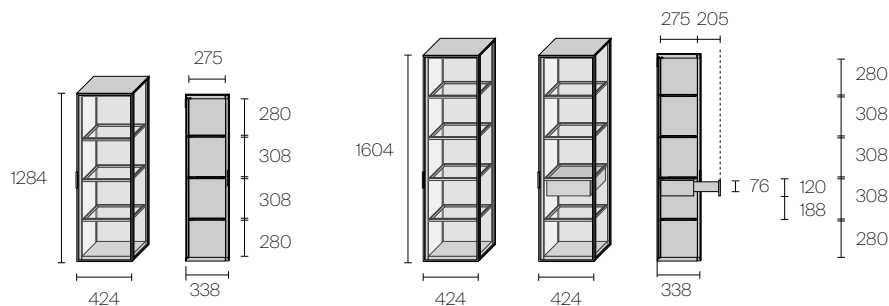

Suspended glass cabinet with flap door

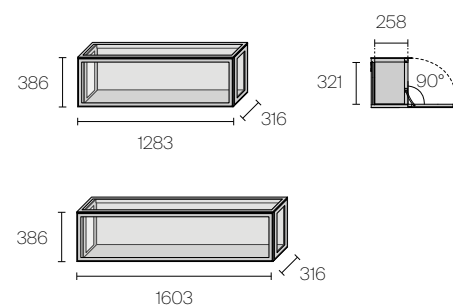

- 1. Handle
- 2. Handle with lock
- 3. Glass door

1

2



3

TECHNICAL DESCRIPTION

EN Alambra is a double-sided system in aluminium and glass with top, cabinets and base in wood available in three varieties: noce, rovere termotrattato and rovere nero. Alternatively, the top can be made of transparent glass. The structure is available in brown, nero, platino and bronzo aluminium. The doors, sides, back panels and shelves are made of tempered glass.

FR Alambra est un système double face en aluminium et verre avec plateau, éléments de rangement et base en bois, disponible en trois essences: noce, rovere termotrattato et rovere nero. Le dessus peut aussi être réalisé en verre transparent. La structure est disponible en aluminium brown, nero, platino et bronzo. Les portes, côtés, fonds et étagères sont en verre trempé.

RU Alambra — это двусторонняя система из алюминия и стекла с деревянной столешницей, ящиками для хранения и цоколем из трех пород дерева: ореха, черного дуба и термообработанного дуба. В качестве альтернативы верхняя часть может быть выполнена из прозрачного стекла. Конструкция доступна из алюминия коричневого, черного, платинового и бронзового цвета. Дверцы, стеновые панели и полки выполнены из закаленного стекла.

IT Alambra è un sistema bifacciale in alluminio e vetro con top, contenitori e basamento in legno disponibile in tre essenze: noce, rovere termotrattato e rovere nero. Il top, in alternativa, può essere realizzato in vetro trasparente. La struttura è disponibile in alluminio brown, nero, platino e bronzo. Ante, spalle, schienali e ripiani sono realizzati in vetro temperato.

ES Alambra es un sistema a doble cara de aluminio y vidrio con top, contenedores y base de madera disponible en tres maderas: noce, rovere termotrattato y rovere nero. El top también puede ser de cristal transparente. La estructura está disponible en aluminio brown, nero, platino y bronzo. Las puertas, los laterales, las partes traseras y los estantes están hechos con vidrio templado.

汉语 Alambra 是一款采用铝合金和玻璃材质打造的双面设计系统，其包含台面、收纳空间和以木材打造的底座，有三种木材可供选择：胡桃木、黑橡木和热处理橡木。台面亦能以透明玻璃制作。柜体材质有棕、黑、铂金和青铜色的铝合金可供选择。门片、侧板、背板和层板采用钢化玻璃打造。

DE Alambra ist ein beidseitiges System aus Aluminium und Glas mit einer Holzplatte, Behältern und einem Sockel, der in drei Holzarten erhältlich ist: Noce, Rovere Termotrattato und Rovere Nero. Die Oberseite ist alternativ aus transparentem Glas gefertigt. Das Gestell ist in Brown, Nero, Platino und Bronzo Aluminium erhältlich. Türblätter, Rückwände und Einlegeböden sind aus gehärtetem Glas gefertigt.

FINISHINGS

Structure

ALUMINIUM



Base, internal equipment

WOOD

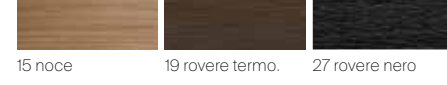

Undertop drawer, internal drawer, accessories

SYNTHETIC LEATHER

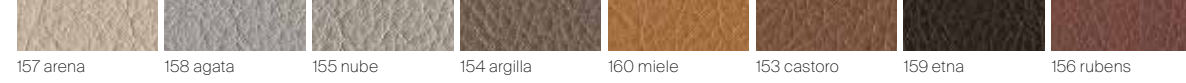

WOOD

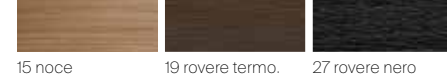

Glass and wooden top

LACQUERED GLASS

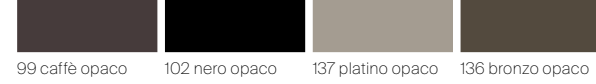

WOOD

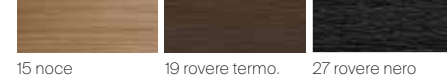

Glass top

LACQUERED GLASS

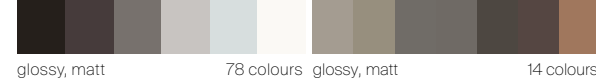

TRANSPARENT GLASS

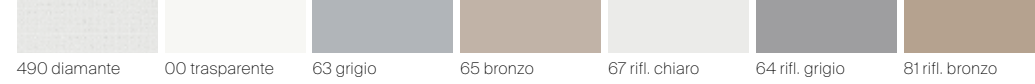

SATINATED GLASS

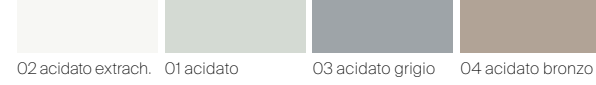

Internal shelf

LACQUERED GLASS



TRANSPARENT GLASS

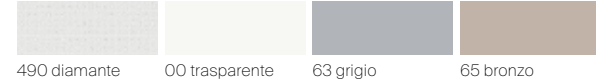

SATINATED GLASS

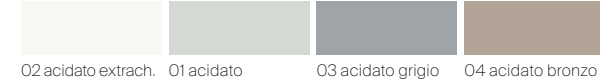

SYNTHETIC LEATHER



Back panel

LACQUERED GLASS



METALIZED GLASS

REFLEX GLASS



DIAMANTE GLASS



MESH GLASS



TRANSPARENT GLASS

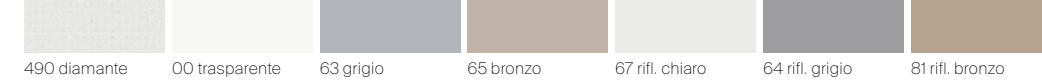

SATINATED GLASS

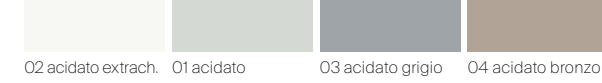

NEUTRAL GLASS

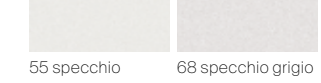

Doors and side panels

LACQUERED GLASS

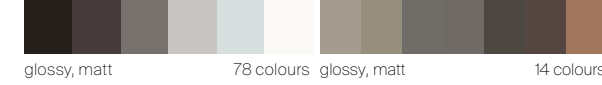

METALIZED GLASS

REFLEX GLASS



DIAMANTE GLASS



MESH GLASS*



TRANSPARENT GLASS

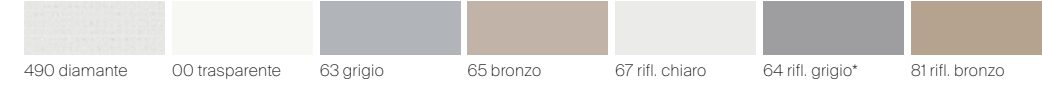

SATINATED GLASS

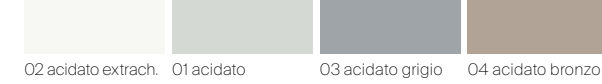

* not available for door with crosspieces

Structure

ALUMINIUM



Glass and wooden top

LACQUERED GLASS

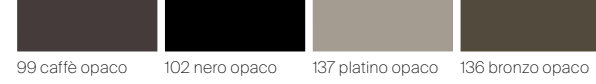

METALIZED GLASS

WOOD



Glass top

LACQUERED GLASS



METALIZED GLASS

TRANSPARENT GLASS

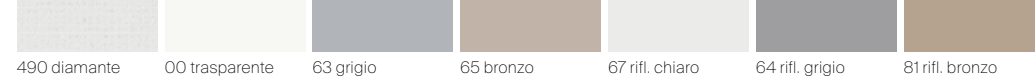

SATINATED GLASS

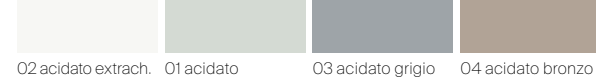

Internal shelf

LACQUERED GLASS

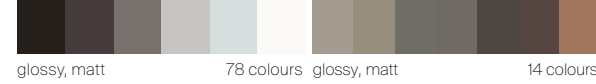

METALIZED GLASS

TRANSPARENT GLASS

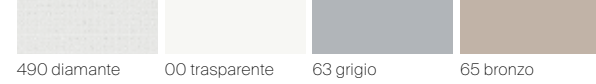

SATINATED GLASS

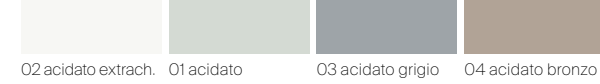

SYNTHETIC LEATHER

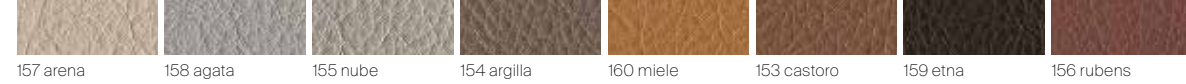

Internal drawer unit

WOOD



Internal drawer

SYNTHETIC LEATHER



Back panel

LACQUERED GLASS



METALIZED GLASS

REFLEX GLASS



DIAMANTE GLASS



MESH GLASS



TRANSPARENT GLASS

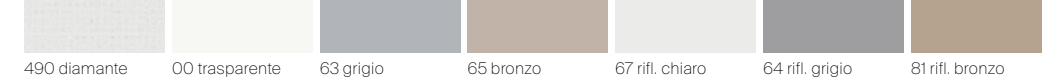

SATINATED GLASS

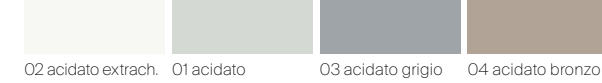

NEUTRAL GLASS

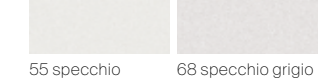

Doors and side panels

LACQUERED GLASS

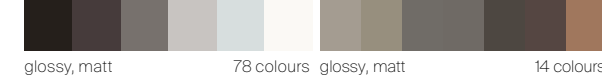

METALIZED GLASS

REFLEX GLASS



DIAMANTE GLASS



MESH GLASS*



TRANSPARENT GLASS

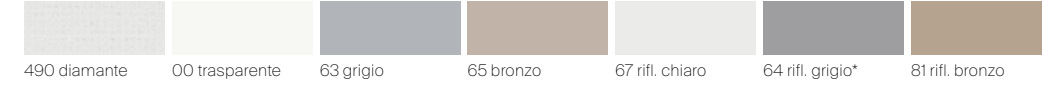

SATINATED GLASS

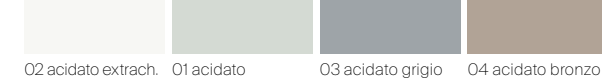

* not available for door with crosspieces

Structure

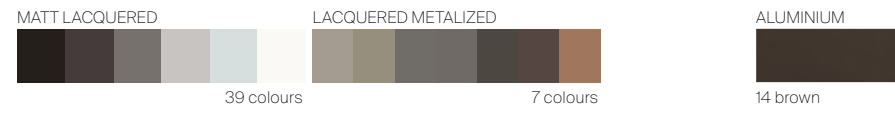

Drawer



Drawer internal lining

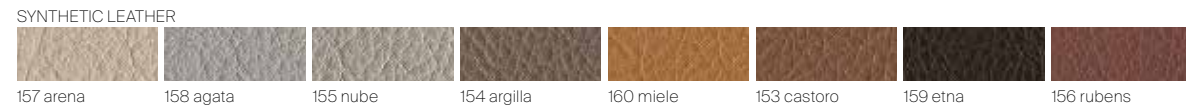

Isola side panels and top



Isola shelves



Isola back panel



Cabinet doors and side panels

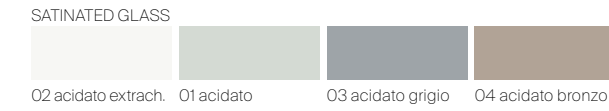
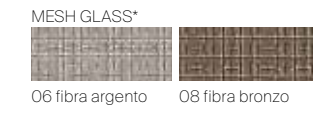
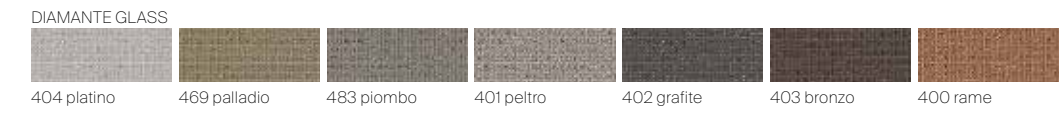

* not available for door with crosspieces

Cabinet back panel

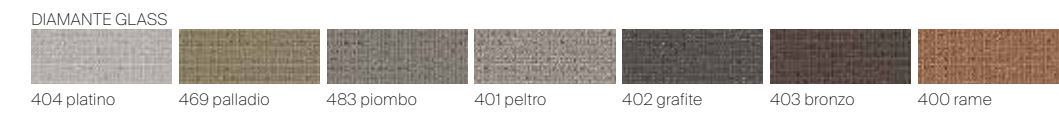

Cabinet shelves

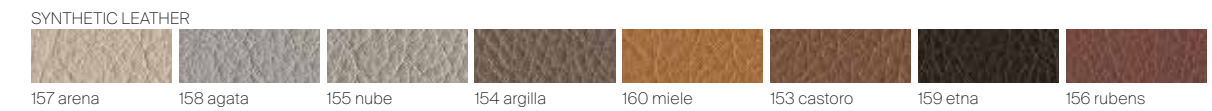
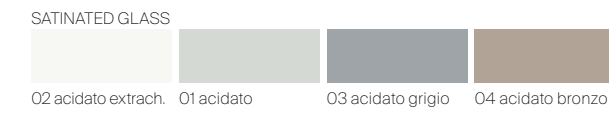
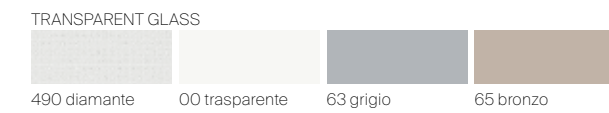
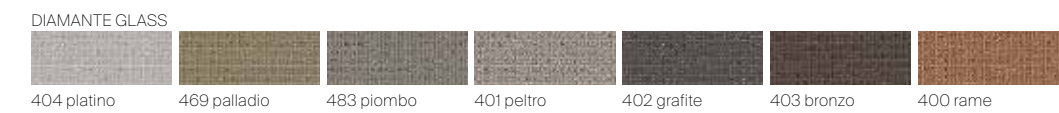



ABACUS LIVING IS A NEW CONCEPT IN THE DAY SYSTEM. THE DESIGN CONSISTS OF A LACQUERED GLASS BOISERIE, A PURE SURFACE LIVING WITH LIGHT AND REFLECTIONS, ON WHICH CABINETS WITH DRAWERS IN GLASS, WOOD OR LITECH ARE PROVIDED, BUT ALSO SLIDING DOORS IN LACQUERED OR TRANSPARENT GLASS AND ULTRA-SLIM SHELVES. THE BACK PANELS ARE PROVIDED WITH UPPER AND LOWER LED LIGHTING SYSTEM.

IT Abacus living è una nuova concezione del sistema giorno. Il progetto si compone di una boiserie di vetro laccato, superficie pura che vive di luce e riflessi, sulla quale si innestano contenitori con cassetti in vetro, in essenza o in Litech, ma anche ante scorrevoli in vetro laccato o trasparente e mensole di sottilissimo spessore. Gli schienali sono dotati di un sistema di illuminazione a led nella parte superiore e inferiore.

DE Abacus living ist ein neues Konzept eines Wohnsystems. Das Design besteht aus einer Vertäfelung aus lackiertem Glas, einer puristischen Oberfläche, die von Licht und Reflexionen lebt, und auf der Behälter mit Schubladen aus Glas, Holz oder Litech sowie Schiebetüren aus lackiertem oder transparentem Glas und sehr dünne Einlegeböden montiert sind. Die Rückenteile sind oben und unten mit einem LED-Beleuchtungssystem ausgestattet.

FR Abacus living est une nouvelle vision de l'espace jour. Ce projet se compose de boiseries en verre laqué, surface pure qui laisse libre cours aux jeux de lumière et de reflets, sur laquelle sont insérés des éléments de rangement avec tiroirs en verre, essences de bois ou Litech, mais aussi des portes coulissantes en verre laqué ou transparent et des étagères ultra-fines. Le fond est équipé d'un système d'éclairage LED en partie haute et basse.

ES Abacus living es una nueva concepción del sistema de día. El proyecto consta de un revestimiento de vidrio lacado, una superficie pura que se nutre de la luz y los reflejos, sobre la que se acoplan los contenedores con cajones de vidrio, madera o Litech, así como puertas correderas de vidrio lacado o transparente y estantes muy finos. Las partes traseras están equipadas con un sistema de iluminación LED en las partes superior e inferior.

RU Abacus living — это новая концепция системы для гостиной. Конструкция состоит из буазери из вертикальной стеклянной панели, чистой поверхности, подчеркиваемой игрой света и отражений, на которую крепятся контейнеры с ящиками из стекла, дерева или Litech, а также раздвижных дверей из лакированного или прозрачного стекла и очень тонких полок. Стеновые панели Сверху и снизу имеют светодиодную подсветку.

汉语 Abacus Living 为日间系统的一个新式概念。该设计由一片漆面玻璃的护壁板构成，洁净的表面透出光线反射，在其之上可嵌入玻璃、木材或 Litech 材质制的收纳抽屉，亦能安装烤漆或透明玻璃制的滑动移门以及极为纤薄的层板。背板的顶部和底部配置 LED 照明系统。



Structure: 83 piombo
Glass: 127 piombo opaco
Suspended cabinets: 19 rovere termotrattato
W 6404 H 1989 D 655

In this photo
Coffee tables: Tray

EN The project concept defining the sliding doors of Abacus living is based on a sliding system integrated into the shelves, completed by a series of glass side panels fixed on the shelves, thus closing the unit. The sliding door is available in transparent, reflective, glossy or matt lacquered glass.

IT Il concept progettuale che definisce le ante scorrevoli Abacus living si basa su un sistema di scorrimento che si integra perfettamente con i ripiani, completato da una serie di spalle laterali in vetro che si inseriscono fra un ripiano e l'altro, chiudendo il vano. L'anta scorrevole in vetro è prevista in versione trasparente, riflettente oppure laccata lucida o opaca.

DE Das Designkonzept, das die Schiebetüren von Abacus living auszeichnet, basiert auf einem Schiebesystem, das sich perfekt in die Regalböden einfügt. Ergänzt wird es durch eine Reihe von gläsernen Seitenwangen, die sich zwischen die einzelnen Regalböden schieben und so das Fach schließen. Die Glasschiebetür ist in transparenter, verspiegelter oder glänzend bzw. matt lackierter Ausführung erhältlich.

FR Le concept du projet qui définit les portes coulissantes du système Abacus living se base sur un mécanisme de glissement parfaitement intégré dans les étagères, complété par une série des panneaux latéraux en verre fixés entre les deux étagères, en créant un espace. La porte coulissante en verre est disponible en version transparente, réfléchissante ou laquée brillante ou mate.

ES El concept de proyecto que define las puertas correderas de Abacus living se basa en un sistema de deslizamiento que se integra perfectamente con los estantes, completado por una serie de paneles laterales en cristal que se intercalan entre un estante y otro, cerrando el compartimento. La puerta corredera en cristal se proporciona en cristal transparente, reflectante o lacado brillante o mate.

RU Концепция дизайна, лежащая в основе раздвижных дверей Abacus living, основана на раздвижной системе, которая идеально интегрируется с полками, дополненными рядом стеклянных перегородок, размещаемых между одной полкой и другой, формируя отдельные секции. Раздвижные стеклянные двери предлагаются в прозрачном, отражающем, глянцевом или матовом лакированном исполнении.

汉语 Abacus Living 滑动移门的设计理念在于滑动系统与层板之间的完美契合。该滑动系统中以多片的玻璃侧板组成并被安装在每片层板之间，用于闭合内部空间。玻璃滑动移门有透明、具反射效果、亮面漆或哑光漆面可供选择。

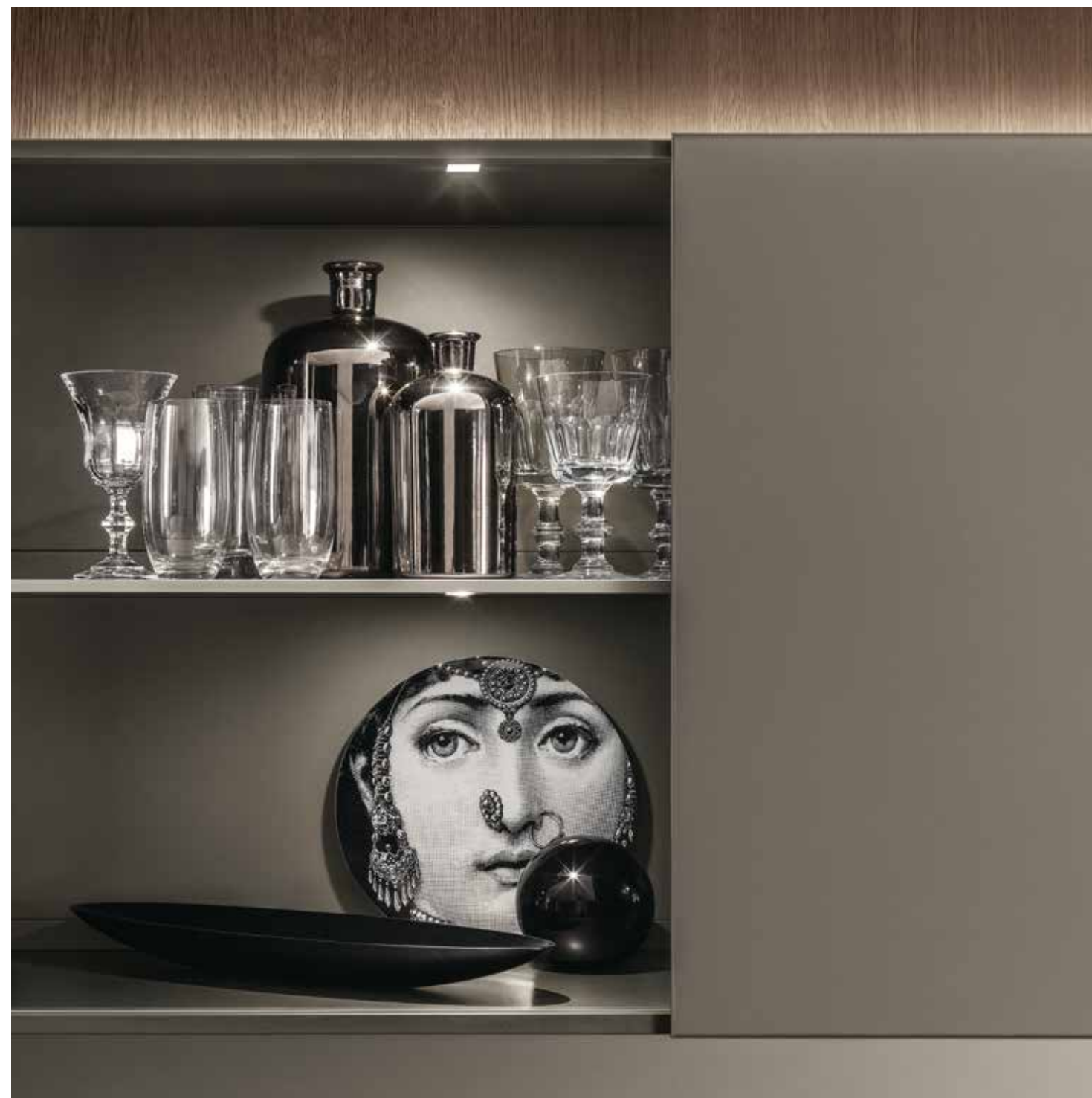

Structure: 83 piombo
Glass: 127 piombo opaco
W 6404 H 1989 D 655







Structure: 84 moro
Glass: 128 moro opaco
Doors: 63 grigio trasparente
W 6404 H 1664 D 505

In this photo
Coffee tables: Tray

Suspended compositions



Structure: 59 grigio chiaro
 Glass: 59 grigio chiaro lucido
 Glass cabinet with sliding door: 59 grigio chiaro lucido
 Panels with upper and lower led lighting
 Shelves with led lighting



Structure: 69 palladio
 Glass: 69 palladio lucido
 Panels with upper and lower led lighting
 Shelves with led lighting

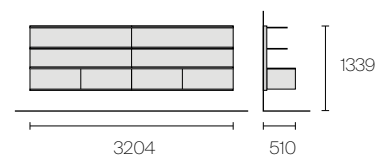
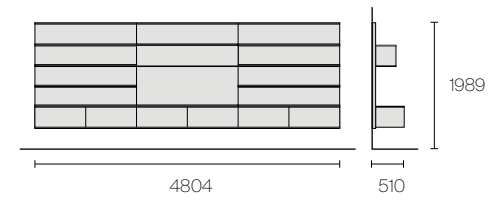

Compositions with suspended drawers



Structure: 58 caffè
 Glass: 99 caffè opaco
 Panels with upper led lighting
 Shelves with led lighting



Structure: 317 grigio artico
 Glass: 600 grigio artico opaco
 Suspended units: 15 noce
 Panels with upper led lighting
 Shelves with led lighting

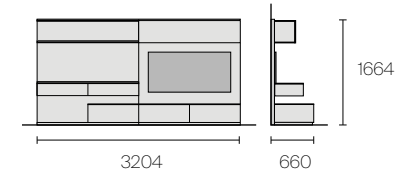
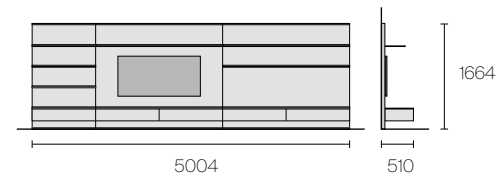

Compositions with Litech suspended units



Structure: 304 platino
 Glass: 137 platino opaco
 Sliding doors: 63 grigio trasparente
 Litech suspended cabinets: G001 crema
 Panels with upper led lighting
 Shelves with led lighting



Structure: 58 caffè
 Glass: 58 caffè lucido
 Litech suspended cabinets: G002 moka
 Panels with upper led lighting
 Shelves with led lighting

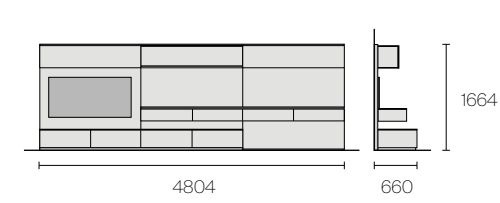
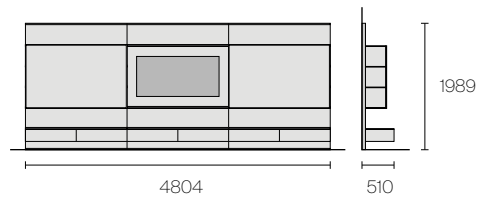

Litech suspended cabinets detail D 450



Structure: 58 caffè
 Glass: 58 caffè lucido
 Litech suspended cabinets: G002 moka
 Panels with upper led lighting
 Shelves with led lighting



1



2

1. Unit with push drawer, profiles 304 platino, glass 141 pepe opaco, drawer interior UB07, light grey aluminium drawer runners
2. Unit with push drawer, profiles 302 grafite, glass 141 pepe opaco, drawer interior UB09, dark grey aluminium drawer runners
3. Unit with flap door, profiles 304 platino, glass 141 pepe opaco, unit interior UB07, internal shelf in lacquered glass
4. Unit with flap door, profiles 302 grafite, glass 141 pepe opaco, unit interior UB09, internal shelf in lacquered glass



3



4



5



6

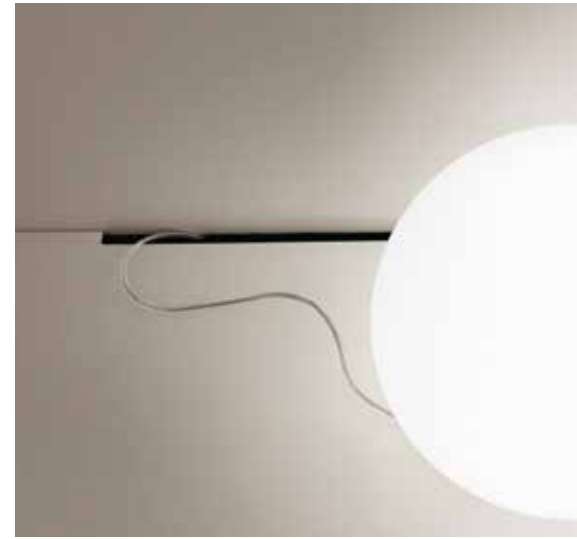

7

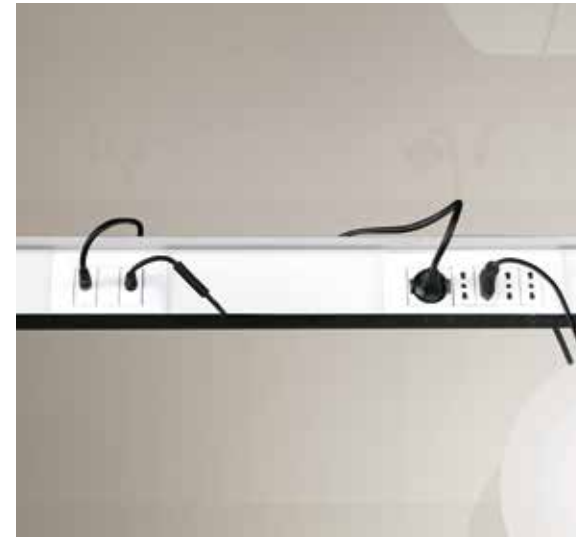

8

5. Lacquered shelf with recessed led spotlight
6. Shelf in tempered glass. The panels are equipped with integrated LED lighting on the upper profile
7. Top D 600 mm in lacquered glass with cable-cut
8. Base D 600 mm with TV cable passage and electrical sockets

TECHNICAL DESCRIPTION

EN The Rimadesio's attention to detail in the contemporary living area is confirmed in the Abacus Living system. The finishing top D 600 is equipped with a dustproof profile; the cable duct is fitted with electrical sockets and TV aerials in order to connect the television to multimedia devices without visible cables. The warm 3000°k LED light is integrated into the upper and lower part of the wall panels.

IT L'attenzione di Rimadesio per i dettagli della zona giorno contemporanea trova conferma nel sistema Abacus living. Il top di finitura P 600 è dotato di profilo antipolvere; la canalina è munita di prese elettriche e antenna tv per consentire di collegare la televisione con dispositivi multimediali senza cavi a vista. La luce led calda a 3000°k è integrata a scomparsa nella parte superiore e inferiore dei pannelli a parete.

DE Rimadesios Liebe zum Detail im modernen Wohnbereich wird im Abacus-Wohnsystem fortgesetzt. Die Oberfläche des P 600 ist mit einem staubdichten Profil versehen; der Kabelkanal ist mit Steckdosen und einer TV-Antenne ausgestattet, damit Fernseh- und Multimediageräte ohne sichtbare Kabel angeschlossen werden können. Das warme LED-Licht mit 3000 K ist verdeckt in die Ober- und Unterseite der Wandpaneele integriert.

FR Le système Abacus living symbolise l'attention portée par Rimadesio aux détails d'un espace de vie contemporain. Le plateau de finition P 600 est doté d'un profil anti-poussière; les rainures sont dotées de prises électriques et d'une antenne TV pour pouvoir raccorder le téléviseur à des appareils multimédia, sans câbles apparents. L'éclairage LED chaud de 3000°k est intégré en partie haute et basse des panneaux muraux.

ES La atención de Rimadesio a los detalles de la sala de estar contemporánea queda confirmada en el sistema Abacus living. El top de acabado P 600 dispone de un perfil antipolvo; el conducto está equipado con tomas de corriente y antena de televisión para poder conectar la televisión con dispositivos multimedia sin cables visibles. La cálida luz LED de 3000°k está integrada de forma oculta en las partes superior e inferior de los paneles de pared.

RU Внимание Rimadesio к деталям в современном жилом пространстве нашло свое подтверждение в системе Abacus living. Столешница глубиной 600 мм оснащена имеет вырез с пылезащитой для провод, кабельный канал оборудован электрическими розетками и штекером для ТВ-антенны, что позволяет подключать телевизор и мультимедийные устройства при скрытых кабелях. Теплый светодиодный свет 3000°k замаскирован в верхней и нижней части стеновых панелей.

汉语 Rimadesio 对当代日间空间细节的重视可从 Abacus Living 系统得到印证。P 600 表面处理的台面具备防尘特点; 装设电源插座和电视天线的电缆管可以收纳电线避免外露, 同时电视能与多媒体设备相连接。3000K 的 LED 暖光灯集成在墙板顶部和底部空间内。

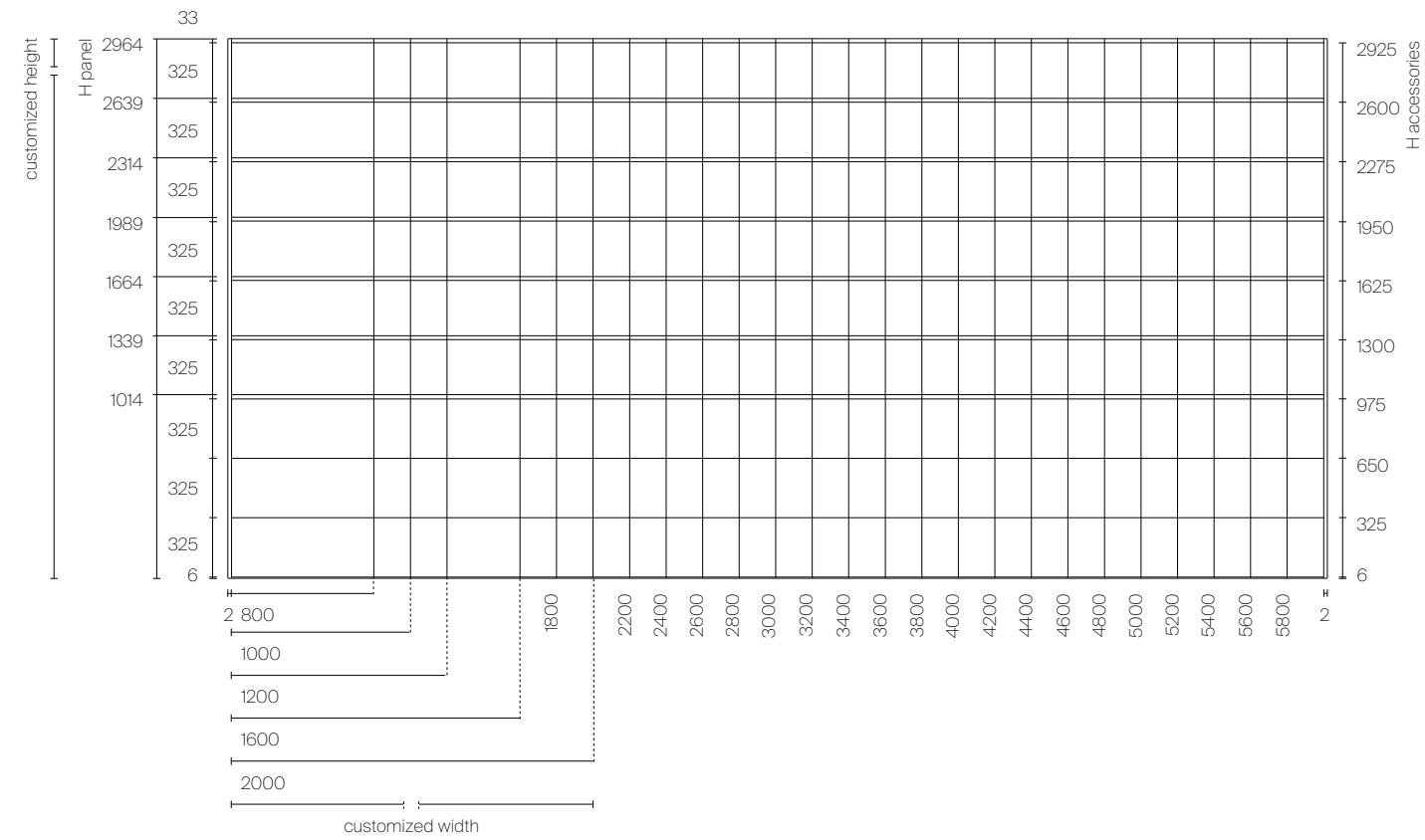

TECHNICAL DESCRIPTION

EN The modularity of the Abacus living system is based on wall fixed panels in lacquered glass available in 5 widths and 7 heights. The panel, the shelf and the floor bench are available in 5 different widths, with the possibility to reduce them on size.

FR La modularité du système Abacus living est basée sur des panneaux au mur en verre laqué disponibles en 5 largeurs et 7 hauteurs. Le panneau, l'étagère et la base au sol sont disponibles en 5 largeurs, avec la possibilité de réduction sur mesure.

RU Модульность системы Abacus living обеспечивается пятью размерами стеновых панелей по ширине и семью по высоте. Панели, полки и основания доступны в 5 размерах по ширине с возможностью урезки.

IT La modularità del sistema Abacus living si basa su pannelli a parete in vetro laccato disponibili in 5 larghezze e 7 altezze. Il pannello, il ripiano e la panca a terra sono disponibili in 5 larghezze, con la possibilità di riduzione a misura.

ES El sistema modular Abacus living se basa en paneles a pared en cristal lacado disponibles en 5 anchuras y 7 alturas. El panel, el estante y la base son disponibles en 5 anchuras, con la posibilidad de reducirlos a medida.

汉语 Abacus Living 的模块化系统是基于烤漆玻璃制成的墙板，共有 5 种宽度和 7 种高度可供选择。墙板、层板和电视矮柜有 5 种宽度可供选择，可根据需求缩短尺寸。各式色彩可在产品目录中查看。

DE Die Modularität des Abacus living Systems basiert auf lackierten Glaswandplatten, die in 5 Breiten und 7 Höhen erhältlich sind. Die Platte, der Fachboden und die Bodenbank sind in 5 Breiten erhältlich, mit der Möglichkeit, sie zu nach Maß zu reduzieren.

Panel in lacquered tempered glass with side aluminium profile

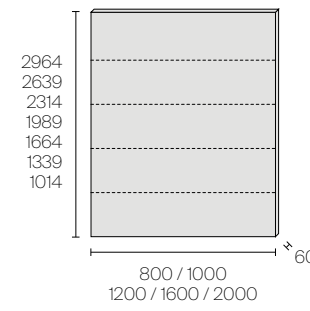

Panel with hidden frame for suspended TV and 1 glass cable cut-out

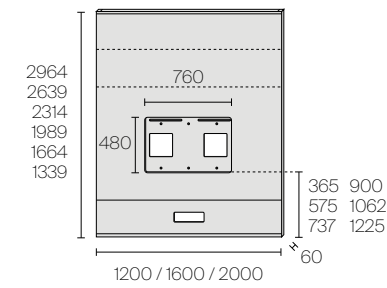

Wall hanging brackets for suspended panels

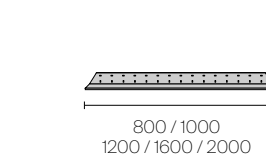

Extensible support for TV

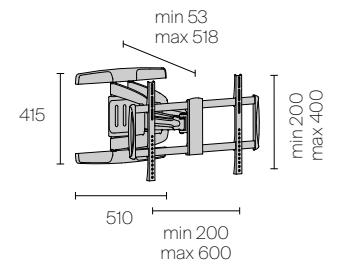

Double base D 600 mm with push drawer

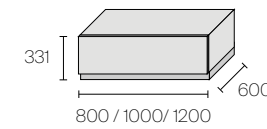

Single and double base with push drawer with glass back panel, double-sided or wall unit

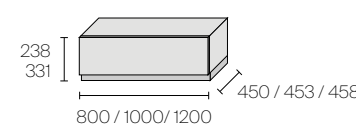

Suspended single and double unit with push drawer with glass back panel or with wall hanging brackets

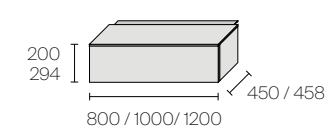

Synthetic leather mat for internal lining

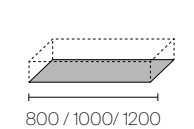

Double base D 600 mm with flap door

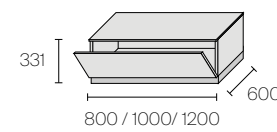

Single and double base with flap door with glass back panel, double-sided or wall unit

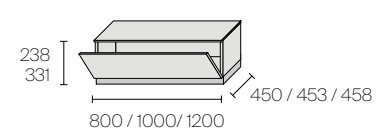

Single and double unit with flap door with glass back panel or with wall hanging brackets

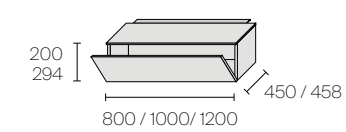

Internal shelf in lacquered glass for cabinet with flap door

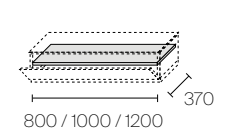

Tempered glass shelves

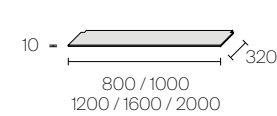

Lacquered shelves

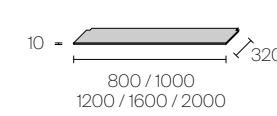

Single top in lacquered glass

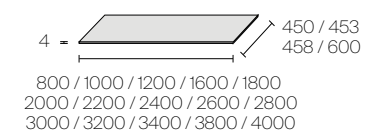

Single top in diamante glass, Litech and wood

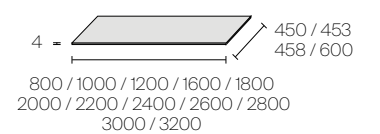

Lacquered glass floor base

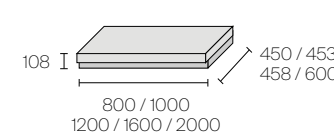

Glass sliding doors D 345

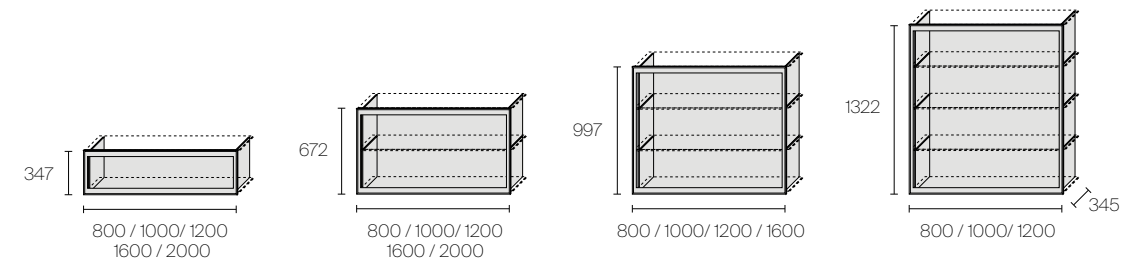

Aluminium cable-duct for glass or wooden top

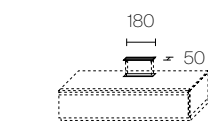

TV cable and socket

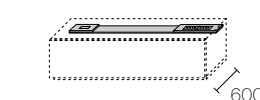

Led lighting for lacquered shelves

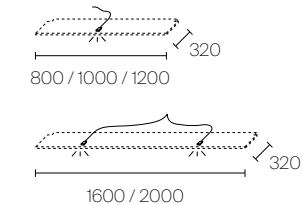

Upper and lower led lighting for panel



FINISHINGS

Structure, baseboard and structural profiles, side profile, laminated shelf, sliding doors, accessories

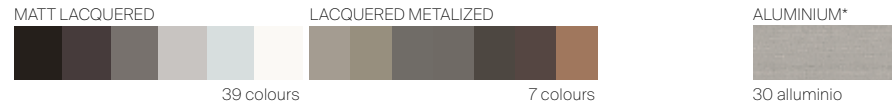

* Only available for baseboard and structural profiles

Panel and lacquered glass floor base

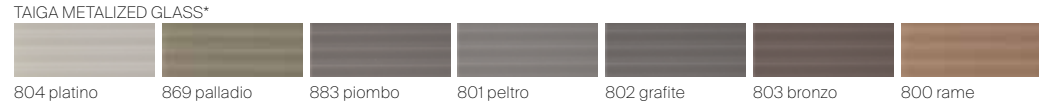
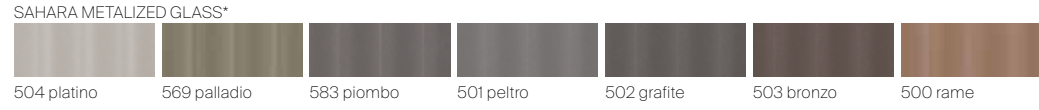
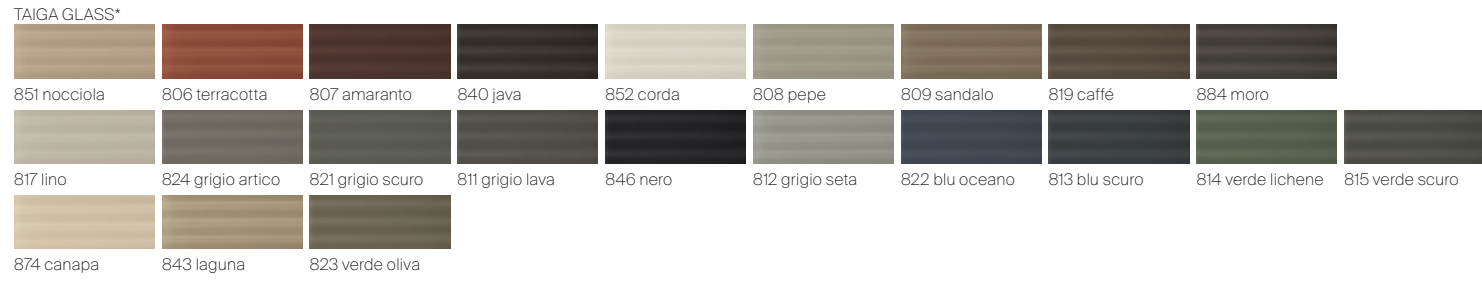
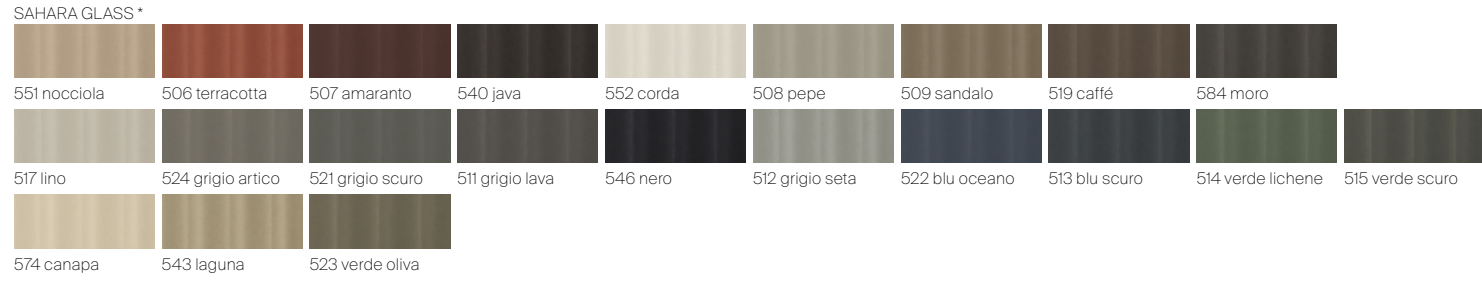

* Only available for panel

Base, units and suspended units

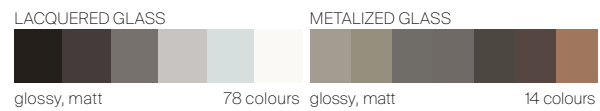

Glass shelf

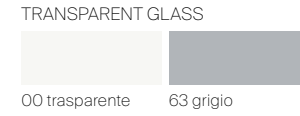

Lacquered shelf

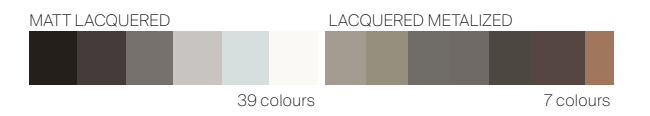

Sliding door

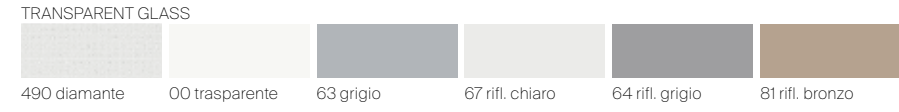
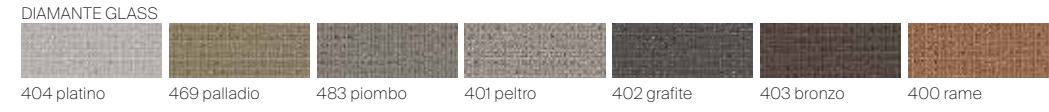
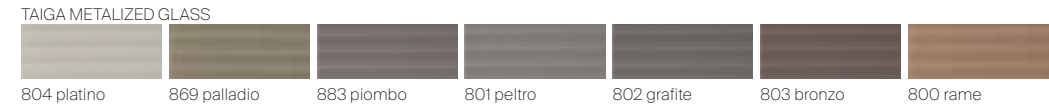
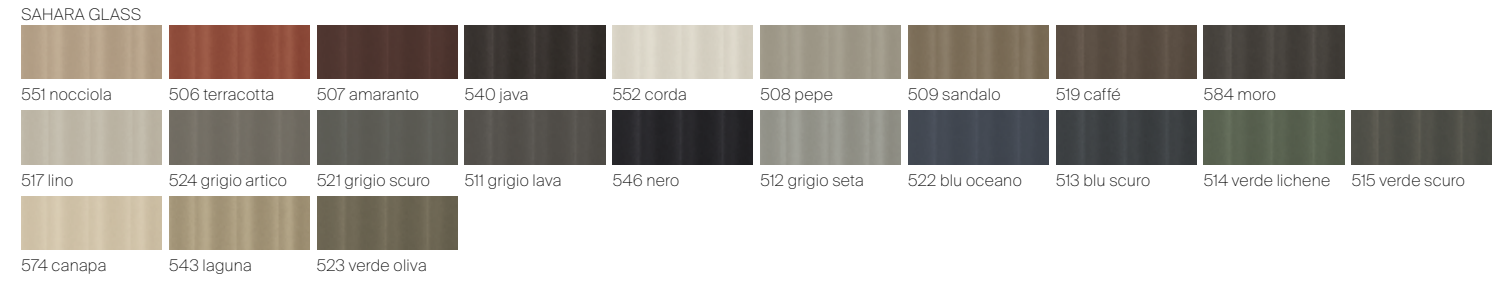
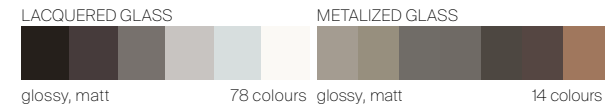

Internal shelf for cabinet with flap door

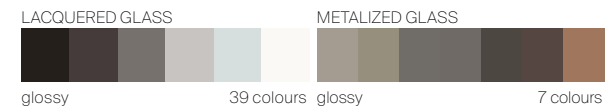

Mat for internal lining



QUALITY AS THE MAIN PURPOSE, ALWAYS AND IN EVERY ASPECT. WITH THIS MISSION RIMADESIO IS CONSTANTLY SEARCHING FOR SOLUTIONS TO IMPROVE ITS OWN ECOLOGICAL STANDARDS.

OBJECTIVE OBTAINED THANKS TO THE USE OF PRECIOUS AND RECYCLABLE MATERIALS, TO THE ABSENCE OF SUBSTANCES THAT CAN BE TOXIC TO HUMANS OR HARMFUL TO THE ENVIRONMENT IN EVERY PHASE OF THE PRODUCTIVE PROCESS, TO THE USE OF TECHNOLOGY AND EVOLVED MACHINERY, POWERED BY CLEAN ENERGY DERIVED FROM PHOTOVOLTAIC SYSTEMS, INSTALLED ON THE GIUSSANO HEADQUARTERS ROOF.

ALUMINIUM, GLASS, WOOD: FULLY RECYCLABLE AND PARTLY ALREADY RECYCLED MATERIALS.

PROOFS OF A REINFORCED GREEN DNA AND WIDE COHERENCE, SIGNALS OF A CONTINUOUS RESEARCH AND A GLANCE TOWARDS THE FUTURE, THAT TAKES SHAPE IN THE TECHNOLOGICAL INNOVATION OF SYSTEMS, DOORS AND FURNITURE, MADE WITH THE AWARENESS OF WANTING TO ENTRUST HUMANS ONLY WITH HIGH VALUE-ADDED ACTIVITIES.

EXCELLENCE SUSTAINABILITY PROJECT

IT Perseguire la qualità, sempre, sotto tutti gli aspetti. Con questa mission Rimadesio ricerca costantemente soluzioni volte a migliorare i propri standard qualitativi ecologici. Obiettivo ottenuto sinergicamente, grazie all'utilizzo di materiali preziosi e riciclabili, all'assenza di sostanze tossiche per l'uomo e nocive per l'ambiente in ogni fase del processo produttivo, all'impiego di tecnologie e macchinari evoluti alimentati con energia pulita proveniente da impianti fotovoltaici, installati sulla copertura dell'headquarter di Giussano. Alluminio, vetro, legno, materiali totalmente riciclabili e in parte già riciclati, ma anche le vernici prive di solventi di Ecoloursystem e i sistemi di imballaggio ecologici. Testimonianze di un dna green consolidato e di una coerenza trasversale, segnali di una continua attività di ricerca e di uno sguardo sempre proteso al futuro che si declina nell'innovazione tecnologica di sistemi, porte ed arredi, realizzati con la consapevolezza di voler affidare all'uomo solo attività dall'alto valore aggiunto.

DE Stets um Qualität bemüht, und zwar in allen Bereichen. Mit dieser Mission im Blick sucht Rimadesio laufend nach Lösungen, um seine ökologischen Qualitätsstandards zu verbessern. Dieses Ziel wurde dank der Verwendung wertvoller und wiederverwertbarer Materialien, dem Verzicht auf für den Menschen giftige und umweltschädliche Stoffe in jeder Phase des Produktionsprozesses und dem Einsatz fortschrittlicher Technologien und Maschinen, die mit sauberer Energie aus den auf dem Dach des Giussano-Hauptsitzes installierten Photovoltaikanlagen betrieben werden, synergetisch erreicht. Aluminium, Glas, Holz, vollständig recycelbare und teilweise bereits recycelte Materialien, aber auch die Lösungsmittelfreien Farben von Ecoloursystem und umweltfreundliche Verpackungssysteme. Ein Zeugnis einer fundierten grünen DNA und einer transversalen Kohärenz, Zeichen einer kontinuierlichen Forschungstätigkeit und eines stets in die Zukunft gerichteten Blicks, der sich in der technologischen Innovation von Systemen, Türen und Einrichtungsgegenständen ausdrückt, die in dem Bewusstsein realisiert werden, den Menschen nur Tätigkeiten mit hohem Mehrwert anzuvertrauen.

FR Poursuivre la qualité, toujours, et à tous les égards. Avec cette mission Rimadesio recherche constamment de solutions au fin d'améliorer ses normes de qualité écologique. Objectif atteint, grâce à l'utilisation de matériaux précieux et recyclables, l'absence à chaque étape de la production de substances toxiques nocives pour l'homme et l'environnement, l'utilisation de technologies et des machines avancées alimentées par l'énergie solaire après l'installation sur le toit de l'usine à Giussano de systèmes photovoltaïques. Aluminium, verre, bois, des matériaux entièrement recyclables et déjà en partie recyclés, mais aussi peinture Ecoloursystem sans solvants et systèmes d'emballage respectueux de l'environnement. Témoignages d'un adn "vert" consolidé et d'une cohérence transversale, signes de recherche continue et d'une tendance à regarder en avant, qui correspond bien à l'innovation technologique des systèmes, des portes et des meubles, réalisés avec la conscience que l'apport de l'homme dans la production ne peut qu'avoir un valeur ajoutée.

ES Perseguir la calidad, siempre, en todos los aspectos. Con esta misión Rimadesio busca constantemente soluciones destinadas a mejorar sus estándares de calidad ecológica. Objetivo conseguido sinérgicamente, gracias al uso de materiales preciosos y reciclables, a la ausencia de sustancias tóxicas para los seres humanos y nocivas para el medio ambiente en cada etapa del proceso de producción, al uso de tecnologías y máquinas avanzadas alimentadas por energía limpia a partir de sistemas fotovoltaicos, instalados en la cobertura del headquarter de Giussano. Aluminio, cristal, madera, materiales completamente reciclables y, en parte, ya reciclados, sino también las pinturas Ecoloursystem libres de disolventes y los sistemas de embalaje ecológicos. Testimonios de un adn green consolidado y una coherencia transversal, señales de una continua investigación y de una vista siempre tendida al futuro que se declina en la innovación tecnológica de sistemas, puertas y muebles, realizados con el conocimiento que desea confiar al hombre sólo actividades de alto valor añadido.

RU Обеспечение качества всегда и во всем. И, в том числе, для достижения этой цели Компания Rimadesio находится в постоянном поиске решений, направленных на улучшение экологических стандартов качества. Эта цель была достигнута благодаря использованию на каждом этапе производственного процесса ценных материалов, пригодных для вторичной переработки, отсутствию токсичных для человека и вредных для окружающей среды веществ, а также благодаря внедрению передовых технологий и оборудования, работающего на чистой энергии от фотоэлектрических систем, установленных на крыше штаб-квартиры компании в г. Джуссано. Компания использует такие материалы, как алюминий, стекло, дерево – полностью перерабатываемые и уже частично переработанные материалы, краски Ecoloursystem, не содержащие растворителей, а также экологически упаковку. Свидетельство консолидированной экологичности и непрерывной последовательности, исследовательской деятельности и взгляда, всегда устремленного в будущее, что выражается в технологических инновациях систем, дверей и мебели, произведенных с осознанием того, что человеку стоит поручать только деятельность с высокой добавленной стоимостью.

汉语 始终至终追求全方位的卓越品质。Rimadesio 肩负使命，不断探索精进生态质量标准的解决方案。品牌目标之达成有赖于珍贵的可回收材料，该材料在所有制造阶段皆不会产生危害人体和环境之有毒物质，同时结合业界前沿的技术以及先进机械装置；而位于朱塞诺 (Giussano) 品牌总部建筑屋顶上的光伏发电设备为上述之机械装置供给干净的能源。除了可完全回收和已部分回收的铝材、玻璃、木材等材料之外，还有环保色彩系统 (Ecoloursystem) 的无溶剂涂料和生态环保型包装。深植的绿色 DNA、跨领域的协同性、持续的研究工作以及具前瞻性的未来展望皆体现在家具系统、各式门类和家具配件的技术创新上，其本着信赖人类才能胜任高附加价值活动的意念研发而成。

GUIDE TO RIMADESIO QUALITY

TEMPERED GLASSES

Single tempered glasses cooked at a temperature of 650 °C. Mechanical resistance 5 times superior in comparison to a normal glass. In case of breaking it crumbles in harmless tiny fragments. In accordance with the UNI EN 12150, UNI 7697 and UNI EN 12600 rules with reference to the security of glasses for decoration purposes.

LAMINATED GLASSES

Double glasses. Between the two glasses a thin plastic film is inserted. Transparent and invisible, it perfectly sticks to both surfaces. Both surfaces are perfectly smooth.Resistance to breaking in accordance with the UNI EN ISO 12543, UNI 7697 and UNI EN 12600 rules. The plastic film witholds the fragments in case of breaking.

GLASS WITH METAL NET AND MESH

Double laminated glasses. Between the two extra-clear glasses and two thin plastic films a micronet fabric is inserted. Through a sophisticated process a metal layer is applied on the fabric, thus creating a characteristic effect of semi transparency. The reflections of the light on the surface of the metallic net are provided by using an extra-clear float glass, which allows maximum transparency and high light transmissions, thanks to the low content of iron oxides. Following the process of hot stratification, the fabric might show minor wave effect, which give the material its characteristic materic and natural look.

ECOLORSYSTEM LACQUERED GLASSES Ecolorsystem is the name that distinguishes the exclusive Rimadesio lacquered glass collection in glossy and matt finishing. Ecological colours produced using exclusively water paints of latest generation, cooked at 110° C. A production technology in the area of glass, with a fully robotised in-house plant that ensures very high quality results and a low environmental impact work cycle. Corrosion resistance conforms to the UNI EN ISO 9227 standard. Temperature fluctuation resistance conforms to the UNI 9429 standard. The colour is inside the double glass, safe from stains, dust and humidity. The thickness of the glass creates an exclusive "depth" effect.

VETRI TEMPERATI

Vetri singoli, sottoposti al trattamento della tempra ovvero ad una cottura alla temperatura di 650 °C. Resistenza meccanica di 5 volte superiore rispetto ad un vetro normale. In caso di rottura si sbriciola in minuti frammenti inoffensivi. Conformi alle norme UNI EN 12150, UNI 7697 e UNI EN 12600 in materia di sicurezza per i vetri d'arredamento.

VETRI STRATIFICATI

Vetri doppi. Fra i due vetri è inserita una sottile pellicola di materiale plastico, trasparente ed invisibile, che aderisce completamente alle due superfici. Entrambe le superfici sono perfettamente lisce. Resistenza alla rottura conforme alle norme UNI EN ISO 12543, UNI 7697 e UNI EN 12600. La pellicola di materiale plastico in caso di rottura trattiene i frammenti.

VETRI STRATIFICATI RETE, MAGLIA E FIBRA

Vetri doppi stratificati. Tra i due vetri extra-chiari e le due sottili pellicole in materiale plastico, è inserito un tessuto in microrete sul quale, tramite un sofisticato processo di materizzazione, viene depositato uno strato metallico che crea un caratteristico effetto di semitrasparenza. Le riflessioni della luce sulla superficie della rete metallizzata sono ottenute con l'utilizzo del vetro float extrachiario che, grazie al basso contenuto di ossidi di ferro, garantisce la massima trasparenza e un'elevata trasmissione luminosa. Il tessuto, a seguito del processo di stratifica a caldo, può presentare delle leggere ondulazioni che conferiscono al materiale il suo caratteristico aspetto materico e naturale.

VETRI LACCATI ECOLORSYSTEM

Ecolorsystem è la denominazione che contraddistingue l'esclusiva collezione di vetri laccati Rimadesio, disponibili in finitura lucida e opaca. Colori ecologici perché prodotti utilizzando esclusivamente vernici all'acqua di ultima generazione, con cottura a 110°C. Una tecnologia produttiva all'avanguardia nell'ambito del vetro, con impianti interni totalmente robotizzati che assicurano risultati di altissima qualità e un ciclo di lavorazione a basso impatto ambientale. Resistenza alla corrosione conforme alla norma UNI EN ISO 9227. Resistenza agli sbalzi di temperatura conforme alla norma UNI 9429. Colori inalterabili nel tempo perché applicati sulla superficie interna del vetro, al sicuro da macchie, polvere e umidità. Lo spessore del vetro crea un esclusivo effetto di "profondità".

TEMPERIERTES GLAS

Einzelgläser, die einer Härtingsbehandlung oder einer Kochtemperatur von 650 °C unterzogen wurden. Mechanische Beständigkeit 5 mal höher als bei normalem Glas. Im Bruchfall zerbröckeln harmlose Bruchstücke in Minuten. Entspricht den Normen UNI EN 12150, UNI 7697 und UNI EN 12600 für die Sicherheit von Möbelgläser.

SCHICHTGLAS

Doppelgläser. Zwischen den beiden Gläsern befindet sich ein dünner Film aus transparentem und unsichtbarem Kunststoff, der vollständig an den beiden Oberflächen haftet. Beide Oberflächen sind komplett glatt. Die Bruchfestigkeit entspricht den Normen UNI EN ISO 12543, UNI 7697 und UNI EN 12600. Die Kunststoffolie bewahrt im Bruchfall die Bruchstücke.

SCHICHTGLAS MIT METALLNETZ, GLASGITTER UND FASER

Hierbei handelt es sich um Doppel-schichtgläser. Zwischen den zwei Extralight-Glasscheiben und den beiden unsichtbaren Plastikfolien wird ein Metall-netz eingesetzt. Das kreiert einen besonderen halbtransparenten Effekt. Der Wiederschein des Lichtes auf der Oberfläche des Metallnetzes wird durch die Verwendung von Extralight Float Glas erzielt. Dank eines kleinen Anteils von Eisenoxid haben wir die maximale Lichtdurchlässigkeit und eine sehr hohe Lichtübertragung erzielen können. Das Netz kann nach dem unter Hitze durchgeführten Schichtungsverfahren leichte Welle aufweisen, was dem Material ein natürliches Aussehen verleiht.

LACKIERTE GLÄSER ECOLORSYSTEM

Ecolosystem ist der Name der lackierten Glas-Kollektion von Rimadesio in der glänzend und matte Ausführung verfügbar. Absolut oekologische Farben, da die modernsten Lackierungen, auf Wasser-Basis, an einer Temperatur von 110° gekocht werden. Eine fortschrittliche Produktionstechnik in der Glasverarbeitung auf einer vollautomatisierten Anlage, die Ergebnisse höchster Qualität und gleichzeitig umweltfreundliche Verarbeitungsverfahren gewährleistet. Korrosion-sprüfung gemäß Bestimmung UNI EN ISO 9227. Temperaturwechselprüfung gemäß Bestimmung UNI 9429. Unverändliche Farben da die Farbung sich im Innen des Doppelglases, geschützt vor Staub, Kratzen und Feuchtigkeit, befindet. Die Dicke des Glases erzeugt eine einzigartige Tiefwirkung.

VERRES TREMPÉS

Verres simples, soumis au traitement de trempe et donc à une température de cuisson de 650 °C. Résistance mécanique 5 fois supérieure à celle du verre normal. En cas de rupture, des fragments inoffensifs s'effritent en quelques minutes. Conforme aux normes UNI EN 12150, UNI 7697 et UNI EN 12600 pour la sécurité des verres pour les meubles.

VERRES STRATIFIÉS

Double verres. Entre les deux verres se trouve une fine pellicule de matière plastique, transparente et invisible, qui adhère complètement aux deux surfaces. Les deux surfaces sont parfaitement lisses. La résistance aux ruptures est conforme aux normes UNI EN ISO 12543, UNI 7697 et UNI EN 12600. La pellicule retient les fragments en cas de rupture.

VERRE FEUILLETÉ AVEC NET, MAILLE ET FIBRA

Double verre stratifié. Entre les deux verres extra clair et les deux films fins de matière plastique un tissu en micro maille est ajouté. A travers un procédé avancé de materisation un couche métallique est déposé sur ce tissu, créant un effet caractéristique translucide. Les reflets de la lumière sur la surface de la maille métallique sont obtenus avec l'utilisation du verre float extra clair, qui, grâce à un faible teneur de oxydes de fer, permet un maximum de transparence et de transmission de la lumière. Suite au procédé de stratification à chaud, le tissu peut présenter de petites ondulations, qui apportent au matériau son aspect caractéristique et naturel.

VERRES LAQUÉS ECOLORSYSTEM

Ecolorsystem est le nom qui caractérise la collection exclusive de verres laqués de Rimadesio disponibles en finition brillante et mate. Couleurs écologiques, parce que produits en utilisant exclusivement vernis à l'eau de dernière génération, cuites à 110°. Une technologie de production avant-gardiste dans le domaine du verre, avec des équipements internes entièrement robotisés qui assurent des résultats de grande qualité et un cycle de production ayant un impact très faible sur l'environnement. Résistance à la corrosion conformément à la norme UNI EN ISO 9227. Résistance aux écarts de température conformément à la norme UNI 9429. Couleurs inaltérables parce qu'ils sont appliqués dans la surface interne du verre, pour protéger de la poussière humidité et taches. L'épaisseur du verre crée un exclusif effet profondeur.

CRISTALES TEMPLADOS

Vidrios simples, sometidos al tratamiento de templado a una temperatura de cocción de 650 °C. Resistencia mecánica de 5 veces mayor que el vidrio normal. En caso de rotura, se desmoronan fragmentos inofensivos. Conforme a las normas UNI EN 12150, UNI 7697 y UNI EN 12600 en materia de seguridad para los cristales en el amueblamiento.

CRISTALES ESTRATIFICADO

Vidrios dobles. Entre los dos vidrios hay una película fina de material plástico, transparente e invisible, que se adhiere completamente a las dos superficies. Ambas superficies son perfectamente lisas. La resistencia a la rotura cumple con las normas UNI EN ISO 12543, UNI 7697 y UNI EN 12600. La película de plástico en caso de rotura retiene los fragmentos.

CRISTALES ESTRATIFICADOS RED METÁLICA, MAILLA Y FIBRA

Cristales dobles estratificados. Entre los dos cristales extraclaros y las dos capas sintéticas, está inserido en un tejido de microred en el que, a través de un sofisticado proceso se deposita una característica de efecto semitransparente. Los reflejos de la luz sobre la superficie de la red metálica se proporcionan con el uso del vidrio float extraclaro que, gracias a su bajo contenido en óxidos de hierro, asegura la máxima transparencia y una alta transmisión de luz. El tejido, siguiendo el proceso de estratificación en caliente, puede presentar ligeras ondulations que dan al material su aspecto característico natural.

CRISTALES LACADOS ECOLORSYSTEM

Ecolorsystem es la denominación que marca la exclusiva colección de los cristales lacados Rimadesio, disponibles en acabado brillante y mate. Colores ecológicos porque productos utilizando exclusivamente pinturas al agua de última generación, con cocción a 110°. Una tecnología productiva a la vanguardia en el ámbito del cristal, con unas instalaciones internas totalmente robotizadas que aseguran resultados de altísima calidad y un ciclo de tratamiento respetuoso del medio ambiente. Resistencia a la corrosión conforme a la norma UNI EN ISO 9227. Resistencia a las variaciones de temperatura conforme a la norma UNI 9429. Colores inalterables en el tiempo porque aplicados en la superficie interior del cristal, al resguardo de manchas, polvo y humedad. El grosor del cristal crea un exclusivo efecto de "profundidad".

ЗАКАЛЕННОЕ СТЕКЛО

Механическая прочность одинарных стекол, подвергнутых закалке, т.е. обжигу при температуре 650°С, в 5 раз выше, чем у обычного стекла. Если такое стекло разбить, оно рассыпется на мелкие неопасные осколки. Соответствует стандартам безопасности UNI EN 12150, UNI 7697 и UNI EN 12600 для мебельного стекла.

МНОГОСЛОЙНОЕ СТЕКЛО

Двойные стекла. Тонкая, прозрачная и невидимая пластиковая пленка прокладывается между двумя стеклами и полностью приклеивается к обеим поверхностям. Обе поверхности идеально гладкие. Проверка прочности на разрыв была выполнена в соответствии со стандартами UNI EN ISO 12543, UNI 7697 и UNI EN 12600. Эта пленка способна удерживать осколки разбившегося стекла.

МНОГОСЛОЙНОЕ СТЕКЛО, СТЕКЛО С СЕТКОЙ

Многослойное двойное стекло. Между двумя сверхпрозрачными стеклами и двумя тонкими пластиковыми пленками вставляется микросетчатое полотно, на которое в ходе сложного производственного процесса наносится металлический слой, благодаря чему и формируется характерный полупрозрачный эффект. Отражение света на поверхности металлизированной сетки достигается за счет использования сверхчистого флот-стекла, которое из-за низкого содержания оксида железа гарантирует максимальную прозрачность и высокую светопропускную способность. В результате процесса наслаивания в горячем виде полотно приобретает небольшие волнистости, которые придают материалу характерную текстуру и натуральный вид.

ЛАКИРОВАННОЕ СТЕКЛО

ECOLORSYSTEM Ecolorsystem — это название эксклюзивной коллекции лакированного стекла Rimadesio, доступной в глянце-вой и матовой отделке. Коллекция характеризуется мягкими спокойными цветами, поскольку при их производстве используются только краски последнего поколения на водной основе, запекаемые при температуре 110°С. В стекольной промышленности в настоящее время внедряются современные производственные технологии, полностью роботизированные заводы, обеспечивающие высокое качество и незначительное воздействие на окружающую среду. Коррозионная стойкость соответствует требованиям положений стандарта EN ISO 9227. Устойчивость к изменениям температуры соответствует требованиям стандарта UNI 9429. Цвет характеризуется исключительной долговечностью, поскольку краски наносятся на внутреннюю поверхность стекла, защищенную от пятен, пыли и влаги. Толщина стекла создает уникальный эффект «глубины».

钢化玻璃 单片玻璃通过淬火工艺,即经 650 °C 高温烧制而成,其机械阻力相较于普通玻璃高出 5 倍。钢化玻璃破裂时会碎成不易伤人的细小碎片。符合家具玻璃安全材质 UNI EN 12150、UNI 7697 以及 UNI EN 12600 的标准。

夹层玻璃

双层玻璃。在两片玻璃之间夹有一层纤薄、透明、无形的塑料薄膜,其完全贴合两片玻璃的表面。两片玻璃的表面皆光滑无比。其抗裂性能符合 UNI EN ISO 12543、UNI 7697 以及 UNI EN 12600 的标准。玻璃破裂时,其碎片会粘在塑料薄膜上,裂而不散。

网夹层玻璃、网格夹层玻璃和纤维夹层玻璃 双层夹层玻璃。在两片超清玻璃和两层纤薄的塑料薄膜之间夹入一层微型网状织物,一道细腻的材质加工工艺,会在织物上覆盖一层金属并创造出半透明的特殊效果。使用超清浮法玻璃产出金属网表面的光线反射,因玻璃的氧化铁含量低,可确保最大透明度和高透光率。通过热分层加工工艺,夹入的织物会有不平整的现象,从而呈现出具有特色的材质纹理和自然感的外观。

环保色彩系统 (Ecolorsystem) 的烤漆玻璃 Ecolorsystem 为 Rimadesio 烤漆玻璃独家系列的名称,有亮面和哑光两种表面处理可供选择。由于仅使用最新一代的水性涂料搭配 110°C 烘烤工序完成而被称为生态环保性色彩;其为超前玻璃业界的生产技术,而全机器人化的内部设备确保极高的产品质量和低环境冲击的加工循环。其抗腐蚀程度符合 UNI EN ISO 9227 的标准。其抗温度急变性符合 UNI 9429 的标准。因色彩涂层夹于玻璃内层,因此不会褪色且不受脏污、灰尘和湿气的影响。玻璃的厚度创造出一种独特的“深度”效果。

ECOLORSYSTEM LACQUERED GLASS

GLOSSY MATT		GLOSSY MATT		GLOSSY MATT		GLOSSY MATT		GLOSSY MATT		GLOSSY MATT			
305	138 cipria	45	97 avorio	59	105 grigio chiaro	40	115 grigio cenere	53	95 bianco neve	50	108 bianco latte		
51	113 nocciola	52	107 corda	56	98 lino	312	145 grigio seta	47	96 grigio perla	78	114 sabbia		
306	139 terracotta	85	130 tufo	310	143 creta	38	121 azzurro cera	36	117 blu Londra	74	110 canapa		
76	116 rosso india	308	141 pepe	317	600 grigio artico	35	100 blu notte	39	122 verde inglese	73	109 giallo kashmir		
75	129 amaranto	309	142 sandalo	88	132 grigio scuro	86	131 blu oceano	314	147 verde lichene	43	119 laguna		
307	140 java	58	99 caffè	311	144 grigio lava	313	146 blu scuro	315	148 verde scuro	33	111 verde oliva		
		84	128 moro	46	102 nero					316	149 verde terra		

ECOLORSYSTEM SAHARA GLASS

551	nocciola sahara	552	corda sahara	517	lino sahara	512	grigio seta sahara	514	verde lichene sahara	574	canapa sahara
506	terracotta sahara	508	pepe sahara	524	grigio artico sahara	522	blu oceano sahara	515	verde scuro sahara	543	laguna sahara
507	amaranto sahara	509	sandalo sahara	521	grigio scuro sahara	513	blu scuro sahara			523	verde oliva sahara
540	java sahara	519	caffè sahara	511	grigio lava sahara						
		584	moro sahara	546	nero sahara						

ECOLORSYSTEM TAIGA GLASS

851	nocciola taiga	852	corda taiga	817	lino taiga	812	grigio seta taiga	814	verde lichene taiga	874	canapa taiga
806	terracotta taiga	808	pepe taiga	824	grigio artico taiga	822	blu oceano taiga	815	verde scuro taiga	843	laguna taiga
807	amaranto taiga	809	sandalo taiga	821	grigio scuro taiga	813	blu scuro taiga			823	verde oliva taiga
840	java taiga	819	caffè taiga	811	grigio lava taiga						
		884	moro taiga	846	nero taiga						

ECOLORSYSTEM METALIZED GLASS

GLOSSY MATT		SAHARA		TAIGA		DIAMANTE	
304	137 platino	504	platino sahara	804	platino taiga	404	platino diamante
69	126 palladio	569	palladio sahara	869	palladio taiga	469	palladio diamante
83	127 piombo	583	piombo sahara	883	piombo taiga	483	piombo diamante
301	134 peltro	501	peltro sahara	801	peltro taiga	401	peltro diamante
302	135 grafite	502	grafite sahara	802	grafite taiga	402	grafite diamante
303	136 bronzo	503	bronzo sahara	803	bronzo taiga	403	bronzo diamante
300	133 rame	500	rame sahara	800	rame taiga	400	rame diamante

NEUTRAL GLASS

55	specchio
68	specchio grigio

TRANSPARENT GLASS

890	trasparente taiga
590	trasparente sahara
490	trasparente diamante
05	trasparente extrachiaro
00	trasparente
63	grigio trasparente
65	bronzo trasparente
390	verde trasparente
391	blu trasparente

SATINATED GLASS

67	riflettente chiaro
64	riflettente grigio
81	riflettente bronzo
891	acidato taiga
591	acidato sahara
02	acidato extrachiaro
01	acidato
03	acidato grigio
04	acidato bronzo
82	nuvola extrachiaro
80	nuvola

MESH GLASS

60	rete alluminio
61	rete inox
62	rete bronzo
66	maglia gold
87	maglia rame
06	fibra argento
08	fibra bronzo







REFLEX GLASS

90	bianco reflex
92	kaki reflex
94	cacao reflex
89	nero reflex





ECOLORSYSTEM MATT LACQUERED

 305 cipria	 45 avorio	 59 grigio chiaro	 40 grigio cenere	 53 bianco neve	 16 bianco latte
 51 nocciola	 52 corda	 56 lino	 312 grigio seta	 47 grigio perla	 78 sabbia
 306 terracotta	 85 tufo	 310 creta	 38 azzurro cera	 36 blu Londra	 74 canapa
 76 rosso india	 308 pepe	 317 grigio artico	 35 blu notte	 39 verde inglese	 73 giallo kashmir
 75 amaranto	 309 sandalo	 88 grigio scuro	 86 blu oceano	 314 verde lichene	 43 laguna
 307 java	 58 caffè	 311 grigio lava	 313 blu scuro	 315 verde scuro	 33 verde oliva
	 84 moro	 13 nero			 316 verde terra

ECOLORSYSTEM LACQUERED METALIZED

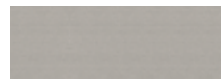
 304 platino	 302 grafite
 69 palladio	 303 bronzo
 83 piombo	 300 rame
 301 petro	





ALUMINIUM

 31 alluminio lucido
 30 alluminio
 14 brown
 318 nickel grigio
 22 nero lucido

LEATHER

 C23 bianco ghiaccio
 C17 sand
 C29 toupè
 C22 caramello
 C28 fango
 C11 moka

SYNTHETIC LEATHER

 157 arena
 158 agata
 155 nube
 154 argilla
 160 miele
 153 castoro
 159 etna
 156 rubens









LUX FABRIC

 T006 gesso
 T052 segale
 T044 acciaio
 T012 marmotta
 T042 ruggine
 T051 salvia

MATERIAL FABRIC

 T020 nebbia
 T019 papiro
 T009 piuma
 T017 roccia
 T001 terracotta
 T003 brandy
 T018 tabacco

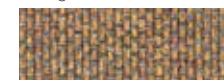
TECH FABRIC

 TT01 duna
 TT03 tortora
 TT05 mosto
 TT07 antracite
 TT09 fumo
 TT10 ghiaccio
 TT11 giada
 TT19 canyon
 TT20 dolomiti
 TT21 cedro





LITECH

 G001 crema
 G002 moka
 G003 pietra
 G004 grigio rigato

MARBLE

 28 calacatta
 184 crystal grey
 186 crystal brown
 180 emperador
 183 noir saint laurent
 187 verde lepanto
 182 rosso lepanto
 181 nero marquinia

MATT MARBLE

 198 calacatta opaco
 194 crystal grey opaco
 191 nero marquinia opaco
 185 crystal white opaco

WOOD

 711 rovere
 15 noce
 19 rovere termotrattato
 27 rovere nero
 710 tinto ebano

SAHARA WOOD

 17 noce sahara
 20 rovere termotrattato sahara

TAIGA WOOD

 701 rovere taiga
 700 tinto ebano taiga

MELAMINE

 07 melaminico olmo
 09 melaminico rovere grigio
 25 melaminico larice carbone

INTERNAL MELAMINE

 UB07 mel. cuoio grigio
 UB09 mel. cuoio brown

Collection designed by Giuseppe Bavuso.

Art direction and graphic project: Juma
Photo: Federico Cedrone, Santi Caleca
Technical photo: F2 Fotografia
Styling: Studiopepe; Patrizia Cantarella with Rossella Ballabio;
Martina Lucatelli with Martina Dalla Bona;
Simona Silenzi Studio; Gaia Marchesini and Giordano Sarno.

Thanks to: Afolki, Ames, Amini Carpets, aponteboretti, Arnolfo di Cambio, Arper, B&B Italia, Bitossi Ceramiche, Carl Hansen & Søn, Claire Lune, Egidio Milesi, Flexform, Flos, Fritz Hansen, Gröpk ceramics, Gruppo Meregalli, Henry Timi, Iittala Karakter, IWATA, Kasthall, Kenko, Knoll, Lindell & Co, Living Divani, Lorenzi Milano, Lorenzo Fransceschinis, Mario Lupo, Maru Gallery, Minotti, Mmairo, Nude Glass, Nuove Forme, Oluce, Project Audio / Audiogamma, Raawii, Rubelli, Salvatori, Scandola marmi, Secolo, Serafino Zani, Skagerak, Unurgent Argilla, Vitra, Vluv / Intentions, When Objects Work.

Artworks:
P. 152 Kazuhito Nagasawa, The place where seeds have fallen, 2012, Officine Saffi
P. 21 William Xerra, Idea di luogo, 1977

Films and print: Optima
Printed in Italy, 2024

RIMADESIO SPA
Via Furlanelli 96
20833 Giuszano (MB) Italy
T +39 0362 3171
rimadesio@rimadesio.it

MILANO FLAGSHIP STORE
Via Visconti di Modrone 26
20122 Milano Italy
T +39 02 76280708
milano@rimadesio.it

LONDON FLAGSHIP STORE
83-85, Wigmore street
1WU 1DL London
T +44 2074 862193
london@rimadesio.co.uk

NEW YORK FLAGSHIP STORE
102 Madison Ave
New York, NY 10016
T +1 917 388 2650
usa@rimadesio.us

www.rimadesio.it

AWARDS

1993	Siparium	Young & Design
2000	Zenit	Award KBB
2001	Zenit	selection Design Index ADI
2002	Siparium	Top100 Frames
2005	Graphis	selection Design Index ADI
2007	Vela	selection Design Index ADI
2008	Vela	mention XXI Premio Compasso d'Oro ADI
2015	Wind	winner Red Dot Award
2016	Cover	Best Furniture System AZ Award
2016	Alambra	selection Design Index ADI
2017	Sail	selection Design Index ADI
2017	Soho	Architectural products AZ awards
2017	Daimon	Interior Design Magazine Best of Year awards
2020	Modulor	People's Choice winner AZ Awards
2020	Modulor	Architectural Products Award of Merit AZ Awards
2020	Modulor	selection Design Index ADI
2021	Francis	selection Design Index ADI
2021	Modulor	LivingEtc Style Awards
2022	Maxi	selection Design Index ADI
2022	Aliante	finalist Interior's best of the Year awards
2022	Aliante	finalist A+Product awards
2023	Maxi	winner German Design Awards
2023	Radius	Architect's Newspaper's Best of Products Awards

PATENTED:

Radius, Aliante, Rialto, Maxi, Sail, Soho, Velaria, Stripe, Daimon, Graphis, Zen, Zen frame, Siparium, Moon, Vela, Luxor, Even, Aura, Spin, Link+, Planet, Flat, Alambra, Abacus living, Self, Cover, Zenit, Dress bold, Abacus.

REGISTERED TRADEMARKS:

Rimadesio, Colorsystem, Litech, Siparium, Velaria, Abacus.



Follow us on Instagram, Facebook, LinkedIn,
WeChat, Weibo, Little Red Book.

